

# ALL-TERRAIN ATF 70G-4



Lift Adjuster  
Option

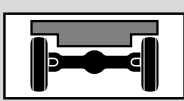

Gewichte / Geschwindigkeiten  
Weights / Working speeds  
Poids / Vitesses  
Pesos / Velocidades de trabajo

	Achse / Axle Essieu / Eje	1	2	3	4	Gesamtgewicht / Total weight Poids total / Peso total
	(t)	12	12	12	12	48*
	(t)	10	10	10	10	40**

\* Incl. 11,9 t Gegengewicht, 9 m / 16 m Auslegerverlängerung, 32 t Unterflasche, 6 t Hakengeschirr, Antrieb 8 x 6, Bereifung 445/95 R 25 (16.00 R 25).

\* Incl. 11.9 t counterweight, 9 m / 16 m boom extension, 32 t hook block, 6 t swivel hook, drive 8 x 6, tyres 445/95 R 25 (16.00 R 25).

\* Incl. de 11,9 t contrepoids, 9 m / 16 m flèche, 32 t moufle, 6 t elingues, entraînement 8 x 6, pneus 445/95 R 25 (16.00 R 25).

\* Incl. contrapeso de 11,9 t, 9 m / 16 m plumín, 32 t gancho, 6 t gancho de bola, tracción 8 x 6, neumáticos 445/95 R 25 (16.00 R 25).

\*\* Sonder-Option / Incl. 3,9 t Gegengewicht, 32 t Unterflasche, Antrieb 8 x 6, Bereifung 445/95 R 25 (16.00 R 25).

\*\* Special option / Incl. 3.9 t counterweight, 32 t hook block, drive 8 x 6, tyres 445/95 R 25 (16.00 R 25).

\*\* Option spéciale / Incl. de 3,9 t contrepoids, 32 t moufle, entraînement 8 x 6, pneus 445/95 R 25 (16.00 R 25).

\*\* Opción especial / Incl. contrapeso de 3,9 t, 32 t gancho, tracción 8 x 6, neumáticos 445/95 R 25 (16.00 R 25).

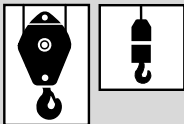
	Traglast / Lifting capacity / Force de levage / Capacidad de elevación	Rollen / Sheaves Pulies / Poleas	Stränge / Parts of line Brins / Ramales de cable	Gewicht / Weight Poid / Peso
	50 t *	5	11	475 kg
	32 t *	3	7	300 kg
	32 t	3	7	300 kg
	12.5 t	1	3	170 kg
	6 t	-	1	150 kg



\* Doppelhaken







\* Rams horn

\* Moufle avec crochet marin

\* Gancho doble

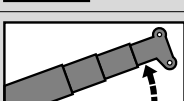

	1	2	3	4	5	6	7	8	9	10	11	12	R1	R2	
	<b>385/95</b> (14.00) km/h	3	4	5	6	8	10	13	17	22	28	36	46	3	
<b>445/95</b> (16.00) <b>525/80</b> (20.5) km/h	3	4	5	7	9	11	15	19	24	31	39	50	3	4	65%
	6	8	10	13	16	20	27	34	44	57	72	85	6	8	30%

	Stufenlos Infinitely variable Progressivement variable Infinitamente variable	Seil Rope Câble Cable	Max. Seilzug Max. single line pull Effort maxi au brin simple Trio máximo por ramal
	0 - 130 m/min für einfachen Strang single line au brin simple ramal simple	16 mm / 205 m	44 kN
	0 - 130 m/min für einfachen Strang single line au brin simple ramal simple	16 mm / 205 m	44 kN
	0 - 2 min <sup>-1</sup>		
	-2° - +82° ca. 33 s approx. 33 s env. 33 s aproximadamente 33 s		
	11.0 m - 44.0 m ca. 230 s approx. 230 s env. 230 s aproximadamente 230 s		

Tragfähigkeiten  
Lifting capacities  
Capacités de levage  
Capacidades de elevación

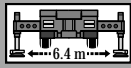
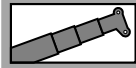

11.9t + 3.1t = 15t  
Option

DIN/ISO/EN

↙ m	11.0 m*	11.0 m	14.8 m	18.7 m	22.5 m	26.3 m	30.1 m	34.0 m	37.8 m	41.6 m	44.0 m
2.5	70.0**	58.0**									
3.0	59.6**	54.8**	50.0	49.3							
3.5	54.8**	49.7	47.0	45.1	42.3						
4.0	49.2	45.4	43.4	41.9	41.0	30.0					
4.5	43.5	41.6	40.3	38.9	38.0	30.0	24.5				
5.0	38.9	37.8	37.6	36.2	35.4	30.0	23.3	18.8			
6.0	31.9	31.8	32.0	31.5	31.2	28.8	21.1	18.8	14.2		
7.0	26.9	26.9	27.2	27.3	27.0	26.4	19.2	17.7	14.2	10.8	9.6
8.0	23.2	23.2	23.5	23.5	23.3	23.6	17.9	16.3	14.2	10.8	9.6
9.0			20.5	20.7	20.6	20.7	16.7	15.0	13.8	10.8	9.6
10.0			18.2	18.3	18.6	18.3	15.7	13.9	12.9	10.8	9.6
11.0			16.2	16.5	16.5	16.1	14.9	13.0	12.1	10.8	9.6
12.0			14.1	14.5	14.4	14.0	14.0	12.1	11.3	10.3	9.0
14.0				11.4	11.3	11.2	11.3	10.7	10.0	9.3	7.8
16.0				9.3	9.3	9.5	9.1	8.8	8.9	8.3	6.9
18.0					7.8	7.9	7.5	7.8	7.4	7.4	6.1
20.0					6.8	6.6	6.7	6.5	6.5	6.2	5.3
22.0						5.6	5.8	5.5	5.5	5.2	4.8
24.0							5.0	4.8	4.7	4.4	4.2
26.0							4.3	4.1	4.0	3.8	3.7
28.0								3.6	3.5	3.2	3.2
30.0								3.1	3.0	2.8	2.8
32.0									2.6	2.4	2.4
34.0									2.3	2.0	2.0
36.0										1.7	1.7
38.0										1.4	1.4
40.0											1.2

\* Nach hinten / \* Over rear / \* A l'arrière / \* Sobre la parte trasera

\*\* Mit Zusatzhubausrüstung / \*\* With additional lifting equipment / \*\* Avec équipement supplémentaire / \*\* Con equipo adicional

Hubhöhen  
Lifting heights  
Hauteurs de levage  
Alturas de elevación

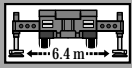
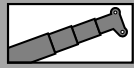

11.9t + 3.1t = 15t  
Option

DIN/ISO/EN

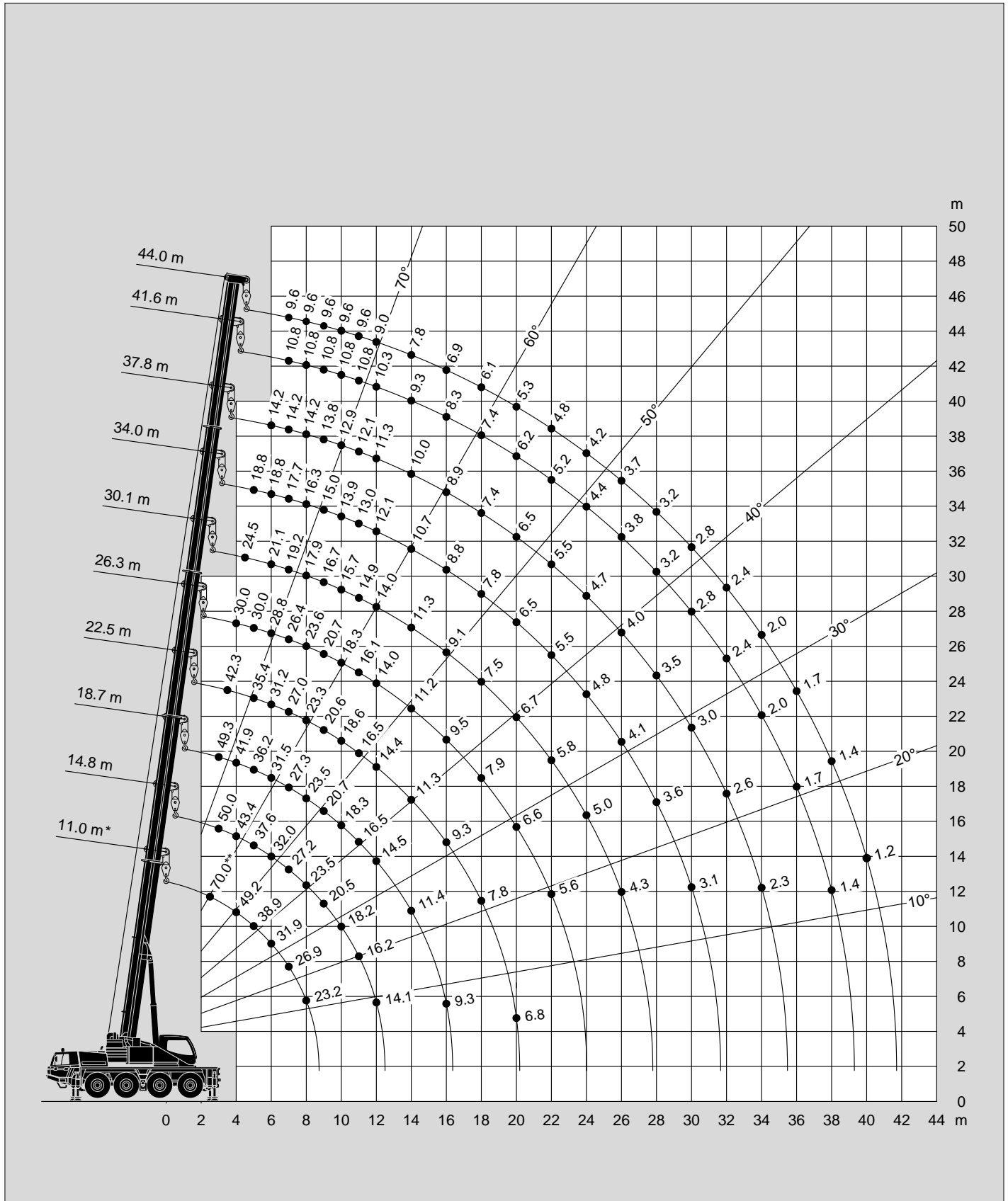

\* Nach hinten / \* Over rear / \* A l'arrière / \* Sobre la parte trasera

\*\* Mit Zusatzhubausrüstung / \*\* With additional lifting equipment / \*\* Avec équipement supplémentaire / \*\* Con equipo adicional

Tragfähigkeiten  
Lifting capacities  
Capacités de levage  
Capacidades de elevación

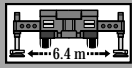
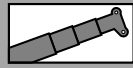

11.9t 'Taxi' Version

DIN/ISO/EN

↙ m	11.0 m*	11.0 m	14.8 m	18.7 m	22.5 m	26.3 m	30.1 m	34.0 m	37.8 m	41.6 m	44.0 m
2.5	70.0**	58.0**									
3.0	59.6**	54.5**	50.0	49.3							
3.5	54.8**	49.4	47.0	45.1	42.3						
4.0	47.8	45.0	43.4	41.9	41.0	30.0					
4.5	42.2	40.6	40.3	38.9	38.0	30.0	24.5				
5.0	37.7	36.9	36.8	36.2	35.4	30.0	23.3	18.8			
6.0	30.9	30.8	31.1	30.8	31.0	28.8	21.1	18.8	14.2		
7.0	26.1	26.0	26.3	26.3	26.2	26.4	19.2	17.7	14.2	10.8	9.6
8.0	22.4	22.4	22.6	22.9	22.6	22.7	17.9	16.3	14.2	10.8	9.6
9.0			19.8	20.1	20.2	19.6	16.7	15.0	13.8	10.8	9.6
10.0			17.3	17.6	17.5	17.0	15.7	13.9	12.9	10.8	9.6
11.0			14.8	15.1	15.0	14.7	14.8	13.0	12.1	10.8	9.6
12.0			12.9	13.2	13.1	12.8	13.0	12.1	11.3	10.3	9.0
14.0				10.4	10.5	10.5	10.3	10.0	10.0	9.3	7.8
16.0				8.4	8.5	8.6	8.3	8.4	8.2	8.1	6.9
18.0					7.2	7.1	7.2	6.9	6.8	6.6	6.1
20.0					6.1	5.9	6.0	5.8	5.7	5.4	5.3
22.0						5.1	5.1	4.9	4.8	4.5	4.5
24.0							4.3	4.2	4.0	3.8	3.8
26.0							3.8	3.6	3.4	3.2	3.2
28.0								3.1	2.9	2.7	2.7
30.0								2.6	2.5	2.2	2.2
32.0									2.1	1.9	1.9
34.0									1.8	1.6	1.6
36.0										1.3	1.3
38.0										1.0	1.0
40.0											0.8

\* Nach hinten / \* Over rear / \* A l'arrière / \* Sobre la parte trasera

\*\* Mit Zusatzhubausrüstung / \*\* With additional lifting equipment / \*\* Avec équipement supplémentaire / \*\* Con equipo adicional

Hubhöhen  
Lifting heights  
Hauteurs de levage  
Alturas de elevación

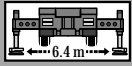
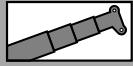

11.9t 'Taxi' Version

DIN/ISO/EN

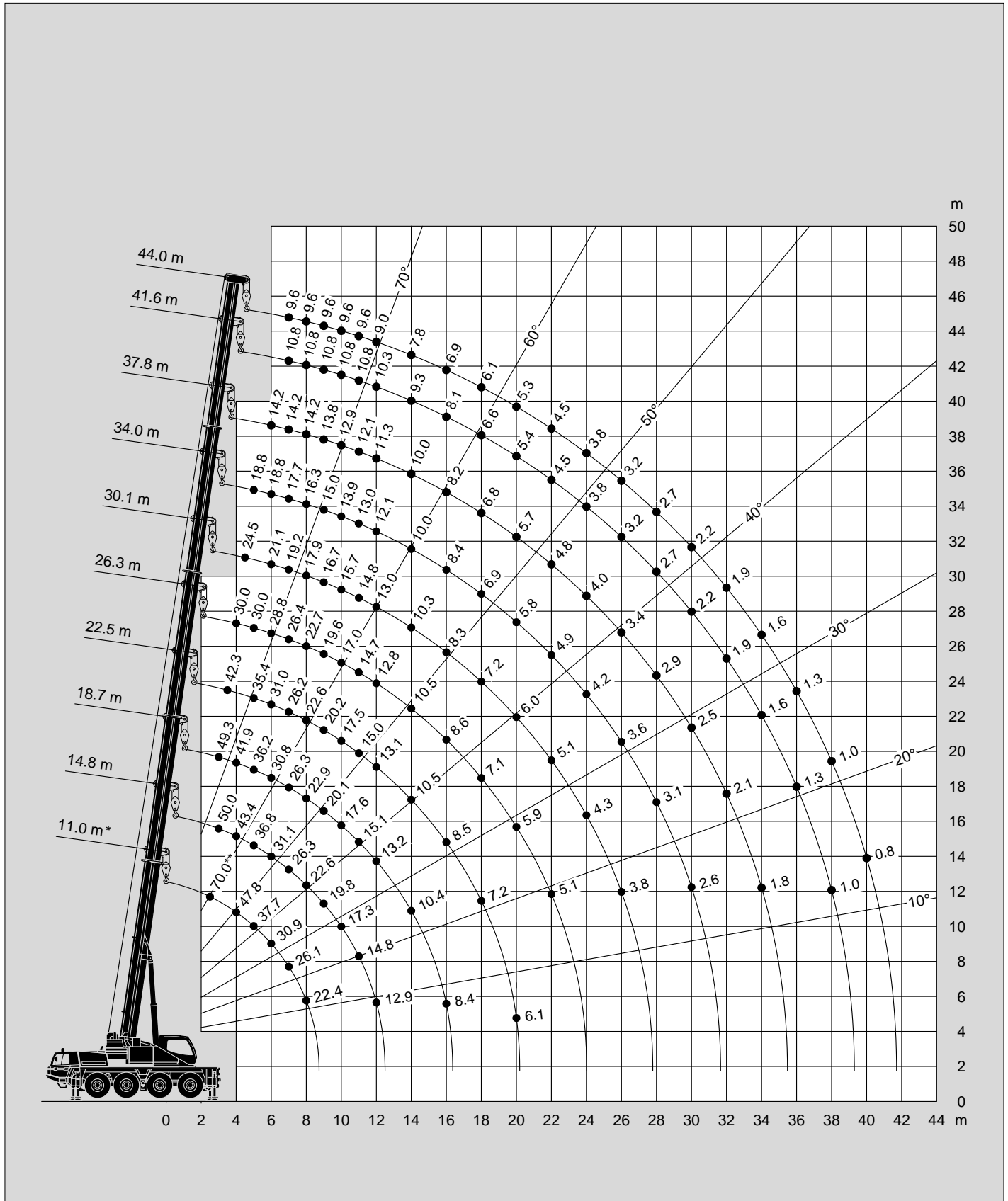

\* Nach hinten / \* Over rear / \* A l'arrière / \* Sobre la parte trasera

\*\* Mit Zusatzhubausrüstung / \*\* With additional lifting equipment / \*\* Avec équipement supplémentaire / \*\* Con equipo adicional

Tragfähigkeiten  
Lifting capacities  
Capacités de levage  
Capacidades de elevación

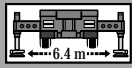
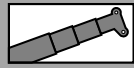

6t

DIN/ISO/EN

↙ m	11.0 m*	11.0 m	14.8 m	18.7 m	22.5 m	26.3 m	30.1 m	34.0 m	37.8 m	41.6 m	44.0 m
2.5	65.4**	58.0**									
3.0	59.6**	53.6**	50.0	49.3							
3.5	50.9	47.9	47.0	45.1	42.3						
4.0	44.2	42.7	42.6	41.8	41.0	30.0					
4.5	39.0	38.4	38.2	38.0	37.6	30.0	24.5				
5.0	34.8	34.7	34.6	34.4	33.7	30.0	23.3	18.8			
6.0	28.5	28.5	28.8	28.9	27.0	26.0	21.1	18.8	14.2		
7.0	23.9	23.9	24.3	23.7	23.1	21.4	19.2	17.7	14.2	10.8	9.6
8.0	18.8	18.8	19.6	20.0	19.4	18.1	17.2	16.2	14.2	10.8	9.6
9.0			16.0	16.4	16.3	15.5	14.9	13.8	13.5	10.8	9.6
10.0			13.3	13.6	13.6	13.4	12.9	12.3	11.7	10.8	9.6
11.0			11.2	11.5	11.7	11.9	11.3	11.3	10.7	10.2	9.6
12.0			9.5	9.9	10.3	10.2	10.1	10.0	9.7	9.0	8.9
14.0				7.5	7.9	7.9	7.9	7.7	7.6	7.3	7.2
16.0				5.9	6.3	6.2	6.2	6.1	5.9	5.7	5.7
18.0					5.1	5.0	5.0	4.9	4.7	4.5	4.5
20.0					4.2	4.1	4.1	4.0	3.8	3.6	3.6
22.0						3.4	3.4	3.2	3.1	2.9	2.9
24.0							2.9	2.7	2.5	2.3	2.3
26.0							2.4	2.2	2.1	1.8	1.8
28.0								1.8	1.7	1.4	1.4
30.0								1.5	1.4	1.1	1.1
32.0									1.1	0.8	0.8
34.0									0.8	0.6	0.6

\* Nach hinten / \* Over rear / \* A l'arrière / \* Sobre la parte trasera

\*\* Mit Zusatzhubausrüstung / \*\* With additional lifting equipment / \*\* Avec équipement supplémentaire / \*\* Con equipo adicional



Hubhöhen  
Lifting heights  
Hauteurs de levage  
Alturas de elevación

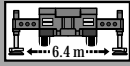
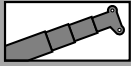

6t

DIN/ISO/EN

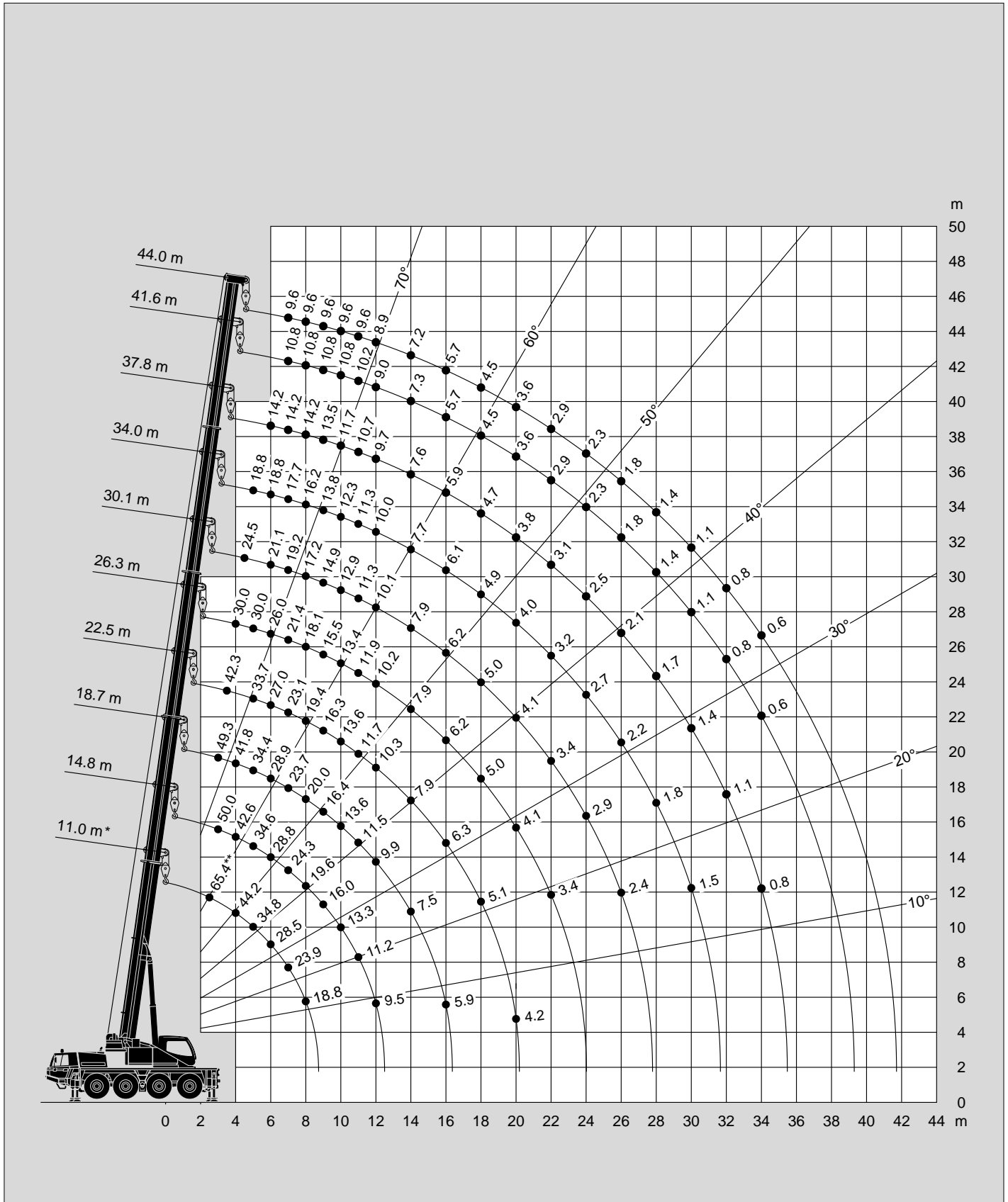

\* Nach hinten / \* Over rear / \* A l'arrière / \* Sobre la parte trasera

\*\* Mit Zusatzhubausrüstung / \*\* With additional lifting equipment / \*\* Avec équipement supplémentaire / \*\* Con equipo adicional

Tragfähigkeiten  
Lifting capacities  
Capacités de levage  
Capacidades de elevación

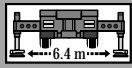
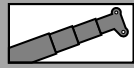

0t

DIN/ISO/EN

 m	11.0 m*	11.0 m	14.8 m	18.7 m	22.5 m	26.3 m	30.1 m	34.0 m	37.8 m	41.6 m	44.0 m
2.5	65.4**	58.0**									
3.0	55.8**	51.6	50.0	49.3							
3.5	48.0	45.3	45.2	44.3	42.3						
4.0	41.9	40.1	40.0	39.0	35.3	30.0					
4.5	37.1	35.8	35.8	33.3	31.3	28.9	24.5				
5.0	33.2	32.1	31.8	29.2	27.7	25.2	22.5	18.8			
6.0	24.2	24.2	24.1	23.2	21.4	19.6	18.4	16.7	14.2		
7.0	17.8	17.5	18.6	18.3	17.0	16.2	14.9	14.6	13.1	10.8	9.6
8.0	13.8	13.1	14.0	14.5	14.2	13.4	13.2	12.3	11.6	10.5	9.6
9.0			11.0	11.5	12.0	11.4	11.2	10.5	9.9	9.1	8.9
10.0			8.9	9.4	9.8	9.8	9.7	9.1	8.5	7.9	7.7
11.0			7.4	7.8	8.2	8.2	8.2	7.9	7.5	6.8	6.7
12.0			6.2	6.6	7.0	6.9	7.0	6.8	6.5	6.0	5.9
14.0				4.8	5.2	5.1	5.2	5.0	4.8	4.6	4.5
16.0				3.6	4.0	3.9	3.9	3.8	3.6	3.4	3.4
18.0					3.1	3.0	3.0	2.9	2.7	2.5	2.5
20.0					2.4	2.3	2.4	2.2	2.1	1.8	1.8
22.0						1.8	1.8	1.7	1.5	1.3	1.3
24.0							1.4	1.2	1.1	0.9	0.9
26.0							1.1	0.9	0.7	0.5	0.5
28.0								0.6	0.5		

\* Nach hinten / \* Over rear / \* A l'arrière / \* Sobre la parte trasera

\*\* Mit Zusatzhubausrüstung / \*\* With additional lifting equipment / \*\* Avec équipement supplémentaire / \*\* Con equipo adicional

Hubhöhen  
Lifting heights  
Hauteurs de levage  
Alturas de elevación

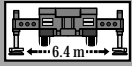
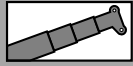

0t

DIN/ISO/EN

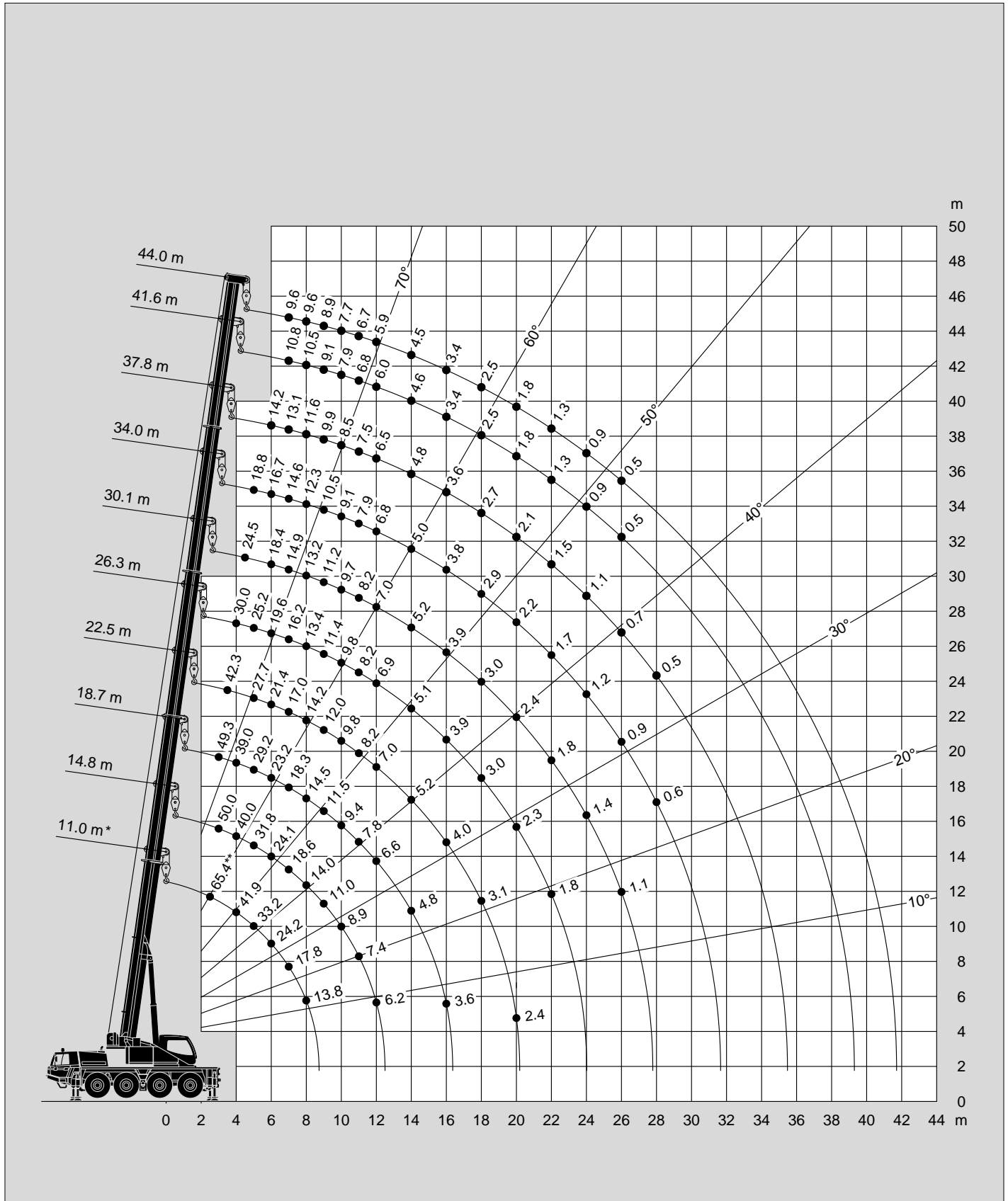

\* Nach hinten / \* Over rear / \* A l'arrière / \* Sobre la parte trasera

\*\* Mit Zusatzhubausrüstung / \*\* With additional lifting equipment / \*\* Avec équipement supplémentaire / \*\* Con equipo adicional

Tragfähigkeiten  
Lifting capacities  
Capacités de levage  
Capacidades de elevación

**360°** **11.9t** + **3.1t** Option = **15t** **DIN/ISO/EN**

m	11.0 m + 9.0 m			30.1 m + 9.0 m			41.6 m + 9.0 m			44.0 m + 9.0 m		
	0°	20°	40°	0°	20°	40°	0°	20°	40°	0°	20°	40°
3.0	10.5*											
3.5	10.5*											
4.0	10.5*											
4.5	10.5*	10.5*		10.5*								
5.0	10.5*	10.5*		10.5*								
6.0	10.5*	10.5*	8.9*	10.5*								
7.0	10.5*	9.9*	8.5	10.5*			6.0					
8.0	10.5*	9.4*	8.1	10.1*	8.1		6.0			5.4		
9.0	10.4*	8.9*	7.8	9.6*	7.7		6.0			5.4		
10.0	9.5*	8.5	7.5	9.0*	7.3	6.4	6.0			5.4		
11.0	8.7	8.2	7.2	8.5	7.0	6.1	6.0	5.4		5.4	5.1	
12.0	8.1	7.8	7.0	8.1	6.7	5.9	5.7	5.2		5.3	4.9	
14.0	7.1	7.2	6.7	7.3	6.2	5.5	5.2	4.9	4.4	4.9	4.6	4.3
16.0	6.3	6.8		6.7	5.8	5.2	4.8	4.5	4.2	4.5	4.3	4.0
18.0				6.0	5.4	4.9	4.4	4.3	3.9	4.2	4.0	3.8
20.0				5.4	5.1	4.7	4.1	4.0	3.7	3.8	3.8	3.6
22.0				4.8	4.8	4.5	3.8	3.7	3.5	3.6	3.5	3.4
24.0				4.3	4.4	4.3	3.6	3.5	3.4	3.3	3.3	3.2
26.0				3.6	3.8	4.0	3.2	3.3	3.2	2.9	3.0	3.0
28.0				3.1	3.2	3.4	2.9	3.0	3.0	2.6	2.7	2.7
30.0				2.6	2.8	2.8	2.6	2.7	2.8	2.3	2.4	2.4
32.0				2.2	2.3		2.3	2.4	2.5	2.0	2.2	2.2
34.0				1.9	1.9		2.0	2.1	2.2	1.8	1.9	2.0
36.0				1.6			1.6	1.8	1.9	1.6	1.7	1.8
38.0							1.4	1.5	1.6	1.3	1.5	1.5
40.0							1.1	1.2	1.3	1.1	1.2	1.3
42.0							0.9	1.0		0.9	1.0	1.0
44.0							0.7	0.8		0.7	0.8	
46.0							0.6	0.6		0.5	0.6	

\* Mit Zusatzhubausrüstung / \* With additional lifting equipment / \* Avec équipement supplémentaire / \* Con equipo adicional

**360°** **11.9t** + **3.1t** Option = **15t** **DIN/ISO/EN**

m	11.0 m + 16.0 m			30.1 m + 16.0 m			41.6 m + 16.0 m			44.0 m + 16.0 m		
	0°	20°	40°	0°	20°	40°	0°	20°	40°	0°	20°	40°
3.0	7.9											
3.5	7.9											
4.0	7.9											
4.5	7.9											
5.0	7.9											
6.0	7.6			4.8								
7.0	7.2			4.8								
8.0	6.7	5.4		4.8			3.5					
9.0	6.3	5.1		4.8			3.5			3.3		
10.0	5.9	4.9		4.8			3.5			3.3		
11.0	5.6	4.7		4.8			3.5			3.3		
12.0	5.3	4.4	3.9	4.8	4.6		3.5			3.3		
14.0	4.7	4.1	3.7	4.8	4.4		3.5			3.3		
16.0	4.2	3.8	3.4	4.8	4.2	3.5	3.5	3.5		3.3		
18.0	3.7	3.5	3.3	4.8	4.0	3.4	3.5	3.3		3.3	3.1	
20.0	3.4	3.3	3.2	4.6	3.8	3.3	3.5	3.1		3.3	3.0	2.8
22.0	3.1	3.2	3.1	4.3	3.6	3.2	3.2	2.9	2.7	3.0	2.8	2.6
24.0	2.8	3.1		4.1	3.5	3.1	3.0	2.8	2.6	2.8	2.7	2.5
26.0				3.7	3.3	3.0	2.8	2.7	2.5	2.6	2.5	2.4
28.0				3.4	3.2	2.9	2.7	2.6	2.4	2.4	2.4	2.3
30.0				2.9	3.0	2.8	2.5	2.4	2.3	2.1	2.2	2.2
32.0				2.5	2.8	2.7	2.2	2.3	2.2	1.9	2.0	2.1
34.0				2.1	2.4	2.6	2.0	2.2	2.1	1.7	1.8	1.9
36.0				1.8	2.0	2.2	1.8	2.0	2.0	1.5	1.6	1.7
38.0				1.6	1.7		1.5	1.8	1.9	1.4	1.5	1.5
40.0				1.3	1.5		1.3	1.5	1.7	1.2	1.3	1.4
42.0				1.1	1.2		1.1	1.3	1.4	1.0	1.2	1.3
44.0				1.0			0.9	1.1	1.2	0.8	1.0	1.1
46.0							0.7	0.8	0.9	0.6	0.8	0.9
48.0							0.5	0.7		0.5	0.6	0.7
50.0								0.5			0.5	

Hubhöhen  
Lifting heights  
Hauteurs de levage  
Alturas de elevación





**11.9t + 3.1t = 15t**
Option
DIN/ISO/EN

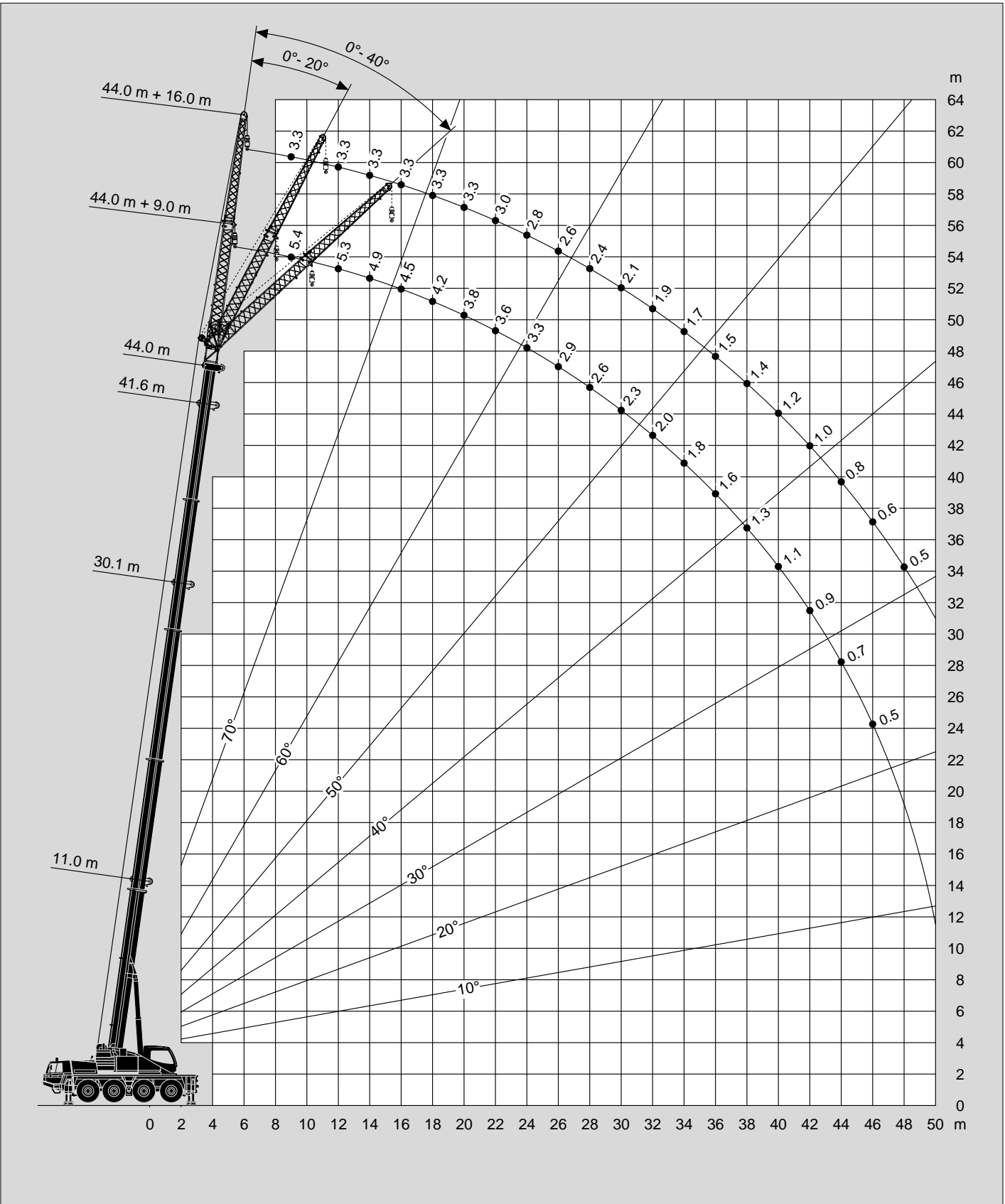

Tragfähigkeiten  
Lifting capacities  
Capacités de levage  
Capacidades de elevación



m	11.0 m + 9.0 m			30.1 m + 9.0 m			41.6 m + 9.0 m			44.0 m + 9.0 m		
	0°	20°	40°	0°	20°	40°	0°	20°	40°	0°	20°	40°
3.0	10.5 *											
3.5	10.5 *											
4.0	10.5 *											
4.5	10.5 *	10.5 *		10.5 *								
5.0	10.5 *	10.5 *		10.5 *								
6.0	10.5 *	10.5 *	8.9 *	10.5 *								
7.0	10.5 *	9.9 *	8.5	10.5 *			6.0					
8.0	10.5 *	9.4 *	8.1	10.1 *	8.1		6.0			5.4		
9.0	10.4 *	8.9 *	7.8	9.6 *	7.7		6.0			5.4		
10.0	9.5 *	8.5	7.5	9.0 *	7.3	6.4	6.0			5.4		
11.0	8.7	8.2	7.2	8.5	7.0	6.1	6.0	5.4		5.4	5.1	
12.0	8.1	7.8	7.0	8.1	6.7	5.9	5.7	5.2		5.3	4.9	
14.0	7.1	7.2	6.7	7.3	6.2	5.5	5.2	4.9	4.4	4.9	4.6	4.3
16.0	6.3	6.8		6.7	5.8	5.2	4.8	4.5	4.2	4.5	4.3	4.0
18.0				6.0	5.4	4.9	4.4	4.3	3.9	4.2	4.0	3.8
20.0				5.2	5.1	4.7	4.1	4.0	3.7	3.8	3.8	3.6
22.0				4.3	4.6	4.5	3.8	3.7	3.5	3.6	3.5	3.4
24.0				3.5	3.8	4.0	3.6	3.5	3.4	3.3	3.3	3.2
26.0				2.9	3.2	3.3	3.1	3.3	3.2	2.9	3.0	3.0
28.0				2.4	2.6	2.7	2.6	2.8	3.0	2.5	2.7	2.7
30.0				2.0	2.2	2.2	2.1	2.3	2.5	2.1	2.3	2.4
32.0				1.7	1.8		1.8	1.9	2.1	1.7	1.9	2.1
34.0				1.4	1.4		1.4	1.6	1.7	1.4	1.6	1.7
36.0				1.1			1.2	1.3	1.4	1.1	1.3	1.4
38.0							0.9	1.0	1.1	0.9	1.0	1.1
40.0							0.7	0.8	0.8	0.7	0.8	0.8
42.0							0.5	0.6		0.5	0.6	0.6

\* Mit Zusatzhubausrüstung / \* With additional lifting equipment / \* Avec équipement supplémentaire / \* Con equipo adicional



m	11.0 m + 16.0 m			30.1 m + 16.0 m			41.6 m + 16.0 m			44.0 m + 16.0 m		
	0°	20°	40°	0°	20°	40°	0°	20°	40°	0°	20°	40°
3.0	7.9											
3.5	7.9											
4.0	7.9											
4.5	7.9											
5.0	7.9											
6.0	7.6			4.8								
7.0	7.2			4.8								
8.0	6.7	5.4		4.8			3.5					
9.0	6.3	5.1		4.8			3.5			3.3		
10.0	5.9	4.9		4.8			3.5			3.3		
11.0	5.6	4.7		4.8			3.5			3.3		
12.0	5.3	4.4	3.9	4.8	4.6		3.5			3.3		
14.0	4.7	4.1	3.7	4.8	4.4		3.5			3.3		
16.0	4.2	3.8	3.4	4.8	4.2	3.5	3.5	3.5		3.3		
18.0	3.7	3.5	3.3	4.8	4.0	3.4	3.5	3.3		3.3	3.1	
20.0	3.4	3.3	3.2	4.6	3.8	3.3	3.5	3.1		3.3	3.0	2.8
22.0	3.1	3.2	3.1	4.3	3.6	3.2	3.2	2.9	2.7	3.0	2.8	2.6
24.0	2.8	3.1		3.9	3.5	3.1	3.0	2.8	2.6	2.8	2.7	2.5
26.0				3.3	3.3	3.0	2.8	2.7	2.5	2.6	2.5	2.4
28.0				2.8	3.2	2.9	2.7	2.6	2.4	2.4	2.4	2.3
30.0				2.3	2.7	2.8	2.3	2.4	2.3	2.1	2.2	2.2
32.0				2.0	2.3	2.5	1.9	2.3	2.2	1.9	2.0	2.1
34.0				1.6	1.9	2.1	1.6	1.9	2.1	1.6	1.8	1.9
36.0				1.4	1.6	1.7	1.3	1.6	1.8	1.3	1.6	1.7
38.0				1.1	1.3		1.1	1.3	1.5	1.0	1.3	1.5
40.0				0.9	1.0		0.9	1.1	1.3	0.8	1.1	1.2
42.0				0.7	0.8		0.7	0.9	1.0	0.6	0.8	1.0
44.0				0.6			0.5	0.7	0.8		0.6	0.8
46.0								0.5	0.6			0.5

Hubhöhen  
Lifting heights  
Hauteurs de levage  
Alturas de elevación

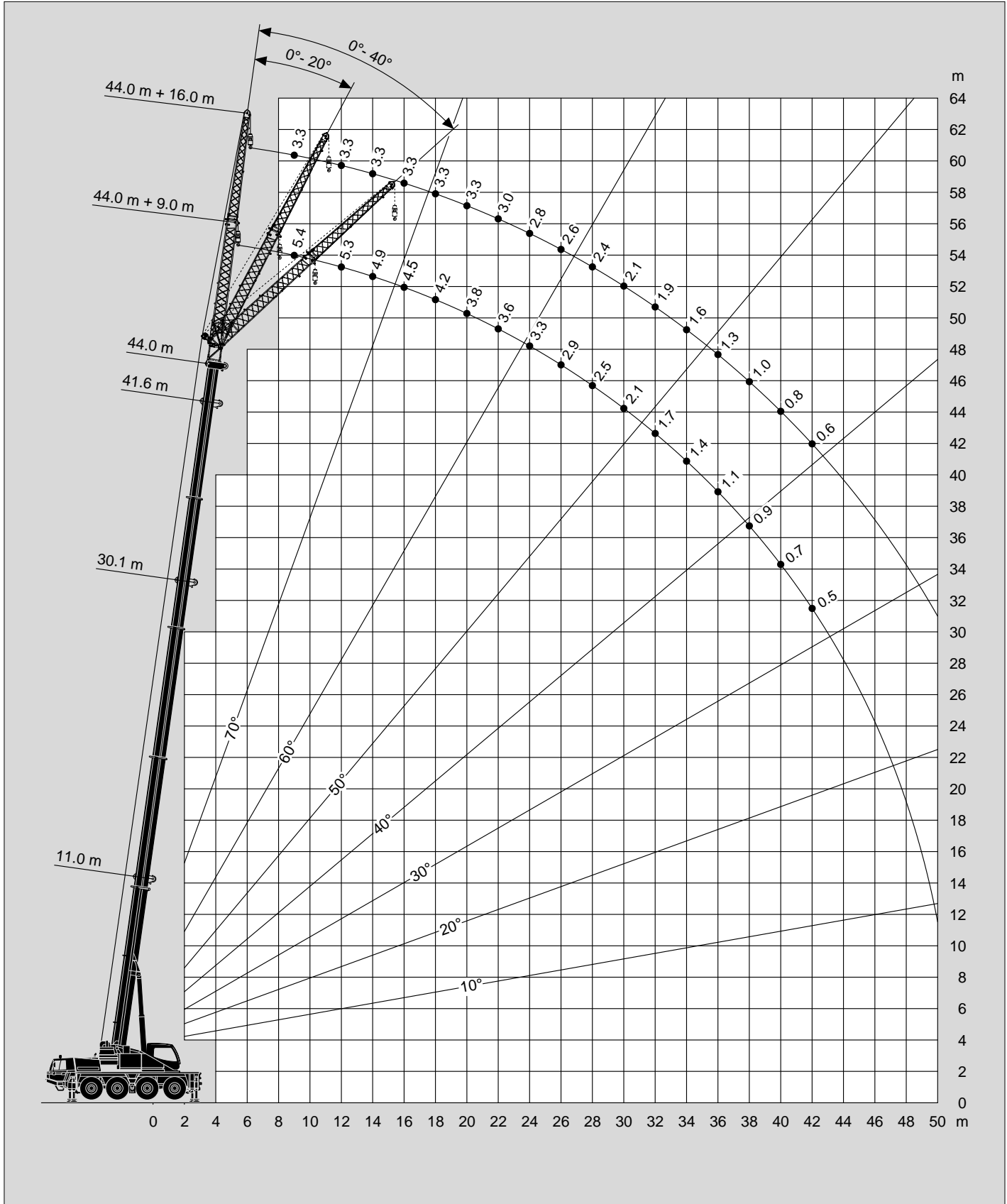

**11.9t 'Taxi' Version**

Tragfähigkeiten  
Lifting capacities  
Capacités de levage  
Capacidades de elevación



m	11.0 m + 9.0 m			30.1 m + 9.0 m			41.6 m + 9.0 m			44.0 m + 9.0 m		
	0°	20°	40°	0°	20°	40°	0°	20°	40°	0°	20°	40°
3.0	10.5*											
3.5	10.5*											
4.0	10.5*	10.5*										
4.5	10.5*	10.5*		10.5*								
5.0	10.5*	10.5*		10.5*								
6.0	10.5*	10.5*	8.9*	10.5*								
7.0	10.5*	9.9*	8.5	10.5*			6.0					
8.0	10.5*	9.4*	8.1	10.1*	8.1		6.0			5.4		
9.0	10.4*	8.9*	7.8	9.6*	7.7		6.0			5.4		
10.0	9.5*	8.5	7.5	9.0*	7.3	6.4	6.0			5.4		
11.0	8.7	8.2	7.2	8.5	7.0	6.1	6.0	5.4		5.4	5.1	
12.0	8.1	7.8	7.0	8.1	6.7	5.9	5.7	5.2		5.3	4.9	
14.0	7.1	7.2	6.7	7.1	6.2	5.5	5.2	4.9	4.4	4.9	4.6	4.3
16.0	6.3	6.8		5.5	5.8	5.2	4.8	4.5	4.2	4.5	4.3	4.0
18.0				4.3	4.7	4.9	4.4	4.3	3.9	4.2	4.0	3.8
20.0				3.4	3.8	4.0	3.5	3.9	3.7	3.5	3.8	3.6
22.0				2.7	3.0	3.2	2.8	3.2	3.4	2.8	3.1	3.4
24.0				2.1	2.4	2.6	2.2	2.5	2.8	2.2	2.5	2.7
26.0				1.6	1.9	2.0	1.8	2.0	2.2	1.7	2.0	2.2
28.0				1.2	1.4	1.5	1.4	1.6	1.8	1.3	1.6	1.7
30.0				0.9	1.1	1.1	1.0	1.2	1.4	1.0	1.2	1.3
32.0				0.6	0.7		0.7	0.9	1.0	0.7	0.9	1.0
34.0					0.5		0.5	0.6		0.7	0.6	0.7
36.0									0.5			0.5
38.0												
40.0												
42.0												

\* Mit Zusatzhubausrüstung / \* With additional lifting equipment / \* Avec équipement supplémentaire / \* Con equipo adicional



m	11.0 m + 16.0 m			30.1 m + 16.0 m			41.6 m + 16.0 m			44.0 m + 16.0 m		
	0°	20°	40°	0°	20°	40°	0°	20°	40°	0°	20°	40°
3.0	7.9											
3.5	7.9											
4.0	7.9											
4.5	7.9											
5.0	7.9											
6.0	7.6			4.8								
7.0	7.2			4.8								
8.0	6.7	5.4		4.8			3.5					
9.0	6.3	5.1		4.8			3.5			3.3		
10.0	5.9	4.9		4.8			3.5			3.3		
11.0	5.6	4.7		4.8			3.5			3.3		
12.0	5.3	4.4	3.9	4.8	4.6		3.5			3.3		
14.0	4.7	4.1	3.7	4.8	4.4		3.5			3.3		
16.0	4.2	3.8	3.4	4.8	4.2	3.5	3.5	3.5		3.3		
18.0	3.7	3.5	3.3	4.7	4.0	3.4	3.5	3.3		3.3	3.1	
20.0	3.4	3.3	3.2	3.8	3.8	3.3	3.5	3.1		3.3	3.0	2.8
22.0	3.1	3.2	3.1	3.0	3.6	3.2	3.0	2.9	2.7	3.0	2.8	2.6
24.0	2.8	3.1		2.4	3.0	3.1	2.4	2.8	2.6	2.4	2.7	2.5
26.0				2.0	2.4	2.8	2.0	2.5	2.5	1.9	2.4	2.4
28.0				1.6	2.0	2.3	1.5	2.0	2.4	1.5	2.0	2.3
30.0				1.2	1.6	1.8	1.2	1.6	1.9	1.2	1.6	1.9
32.0				0.9	1.2	1.4	0.9	1.3	1.6	0.9	1.2	1.5
34.0				0.7	0.9	1.1	0.6	1.0	1.2	0.6	0.9	1.2
36.0					0.7	0.8		0.7	0.9		0.7	0.9
38.0								0.5	0.7		0.5	0.7
40.0												
42.0												
44.0												
46.0												



Hubhöhen  
Lifting heights  
Hauteurs de levage  
Alturas de elevación







DIN/ISO/EN

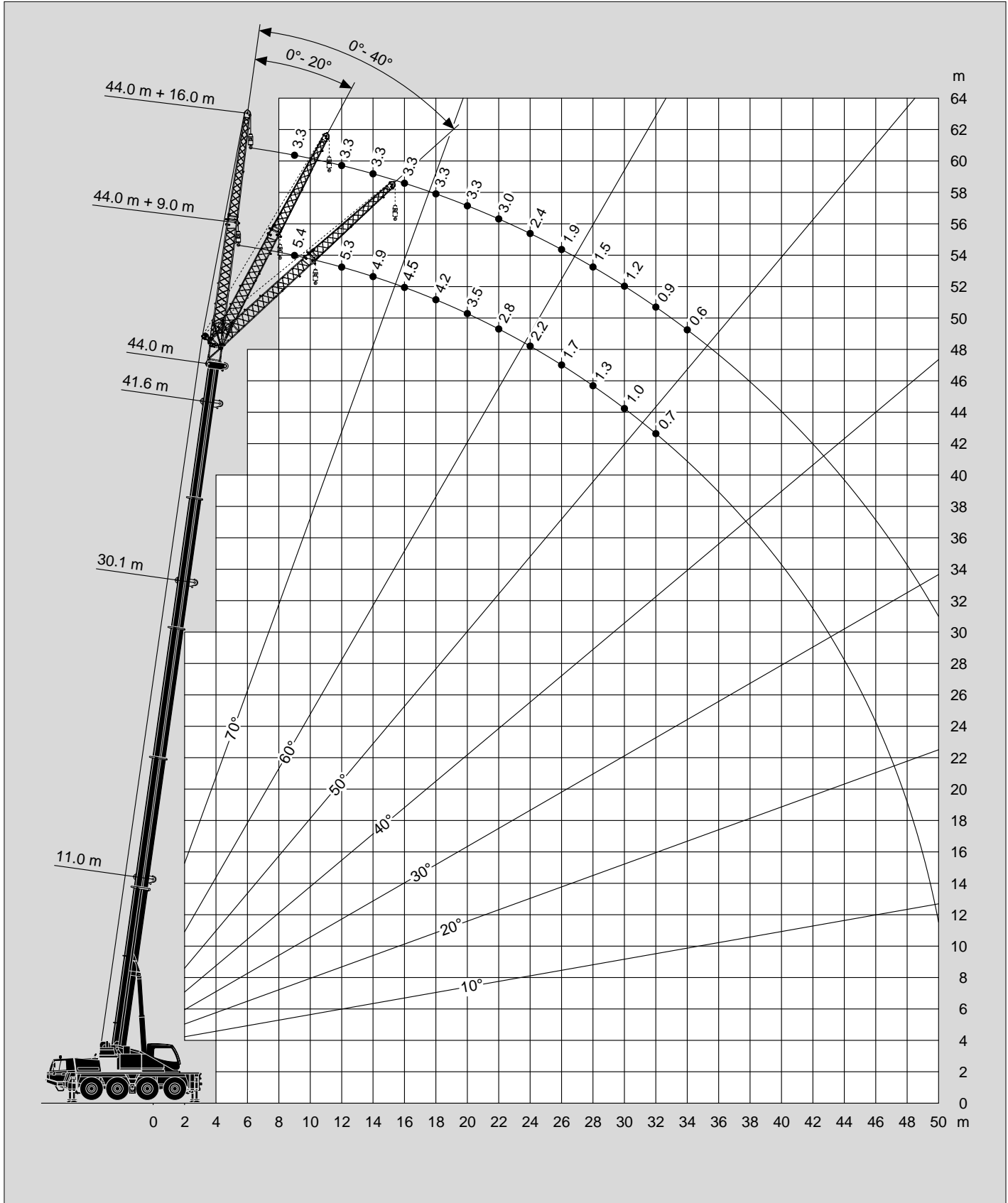

Tragfähigkeiten  
Lifting capacities  
Capacités de levage  
Capacidades de elevación

Hubhöhen  
Lifting heights  
Hauteurs de levage  
Alturas de elevación



↘ m	11.0 m*	14.8 m*	18.7 m*
3.0	21.5	21.9	22.1
3.5	19.6	20.0	20.2
4.0	17.9	18.3	18.3
4.5	16.5	16.9	16.5
5.0	14.8	15.5	15.0
6.0	11.5	12.2	12.5
7.0	9.2	9.9	10.2
8.0	8.4	8.2	8.5
9.0		6.9	7.2
10.0		5.8	6.2
11.0		5.0	5.3
12.0		4.3	4.6
14.0			3.6
16.0			2.7
18.0			

\* Oberwagenverriegelung eingelegt \* Superstructure verrouillé  
\* Superstructure locked \* Bloqueo de superestructura

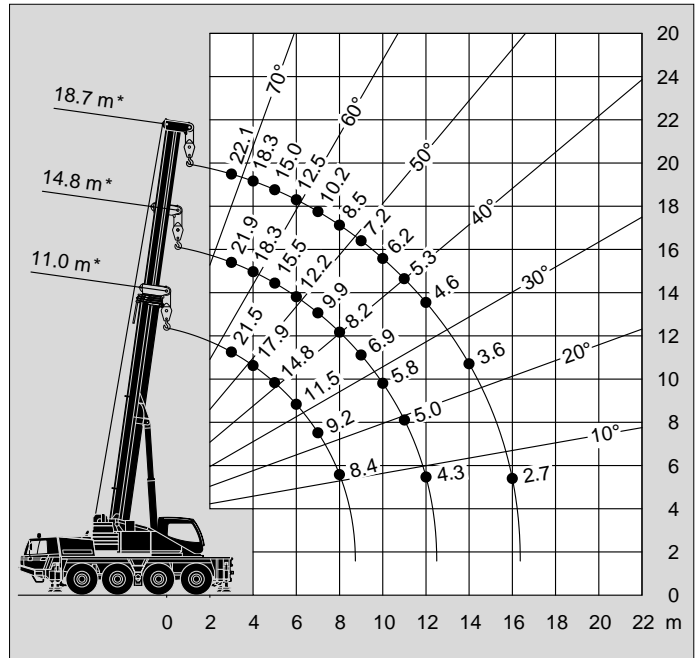

↘ m	11.0 m*	14.8 m*	18.7 m*
3.0	21.5	22.0	21.1
3.5	19.6	19.7	18.6
4.0	17.8	17.4	16.5
4.5	15.2	15.5	14.8
5.0	13.2	13.9	13.3
6.0	10.2	10.9	11.1
7.0	8.1	8.8	9.1
8.0	6.6	7.2	7.6
9.0		6.0	6.4
10.0		5.1	5.4
11.0		4.3	4.6
12.0		3.7	4.0
14.0			3.0
16.0			2.2
18.0			

\* Oberwagenverriegelung eingelegt \* Superstructure verrouillé  
\* Superstructure locked \* Bloqueo de superestructura

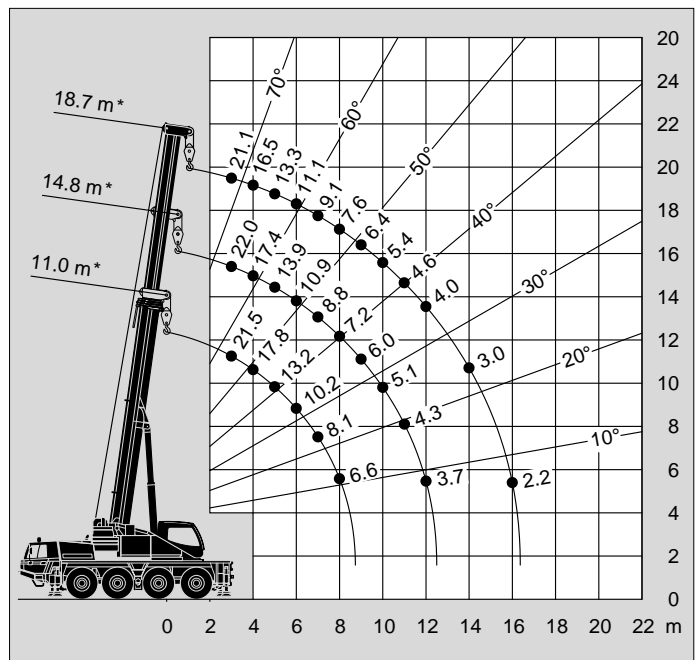

Tragfähigkeiten  
Lifting capacities  
Capacités de levage  
Capacidades de elevación

Hubhöhen  
Lifting heights  
Hauteurs de levage  
Alturas de elevación



↘ m	11.0 m*	14.8 m*	18.7 m*
3.0	18.7	17.6	16.4
3.5	15.9	15.1	14.3
4.0	13.6	13.3	12.7
4.5	11.5	11.7	11.3
5.0	9.9	10.5	10.1
6.0	7.5	8.2	8.3
7.0	5.8	6.5	6.8
8.0	4.6	5.2	5.6
9.0		4.3	4.6
10.0		3.5	3.8
11.0		2.9	3.2
12.0		2.4	2.7
14.0			1.9
16.0			1.3
18.0			

\* Oberwagengerriegelung eingelegt \* Superstructure verrouillé  
\* Superstructure locked \* Bloqueo de superestructura

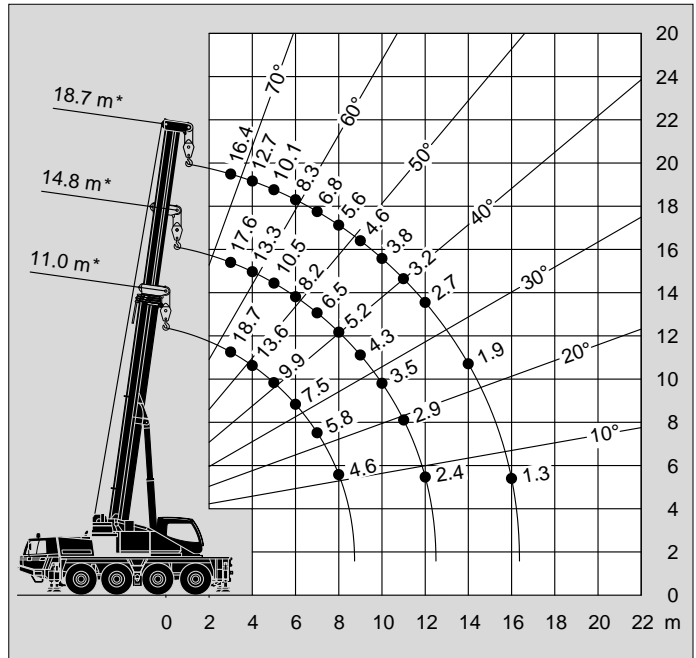

↘ m	11.0 m*	14.8 m*	18.7 m*
3.0	13.8	13.1	12.4
3.5	11.6	11.2	10.7
4.0	9.4	9.7	9.3
4.5	7.8	8.5	8.2
5.0	6.6	7.3	7.3
6.0	4.8	5.5	5.9
7.0	3.5	4.2	4.5
8.0	2.6	3.2	3.6
9.0		2.5	2.8
10.0		1.9	2.3
11.0		1.5	1.8
12.0		1.1	1.4
14.0			0.8
16.0			
18.0			

\* Oberwagengerriegelung eingelegt \* Superstructure verrouillé  
\* Superstructure locked \* Bloqueo de superestructura

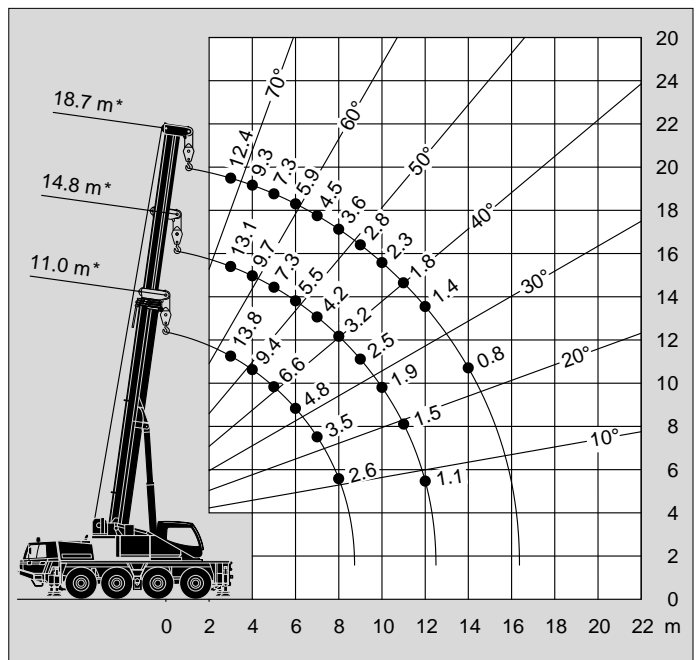

**Anmerkungen zu den Traglasttabellen**

Die Tragfähigkeiten im Festigkeitsbereich basieren auf DIN 15018 Blatt 2 und Blatt 3 und F.E.M.

Die Tragfähigkeiten im Standsicherheitsbereich entsprechen DIN 15019 Teil 2 / ISO 4305 / EN 13000.

In Abhängigkeit der Auslegerlänge sind bei den Traglasttabellen Windgeschwindigkeiten von 10 m/s bis max. 15 m/s zulässig.

Die Tragfähigkeiten sind in metrischen Tonnen angegeben.

Das Gewicht des Lasthakens bzw. der Hakenflasche und weiterer Anschlagmittel ist von der Tragfähigkeit abzuziehen.

Die Tragfähigkeiten für den Teleskopausleger gelten nur bei demon- tierter Spitze.

Die Ausladung ist der horizontale Abstand von Mitte Drehkranz bis Mitte freihängender, nicht schwingender Last.

Tragfähigkeitsänderungen vorbehalten.

Obige Angaben dienen nur zur Information. Die Bedienungsanlei- tungen müssen zu Rate gezogen werden, bevor die Maschine in Betrieb genommen wird. Alle hier gemachten Angaben beziehen sich auf die Standard-Ausführung. Jegliche Ausrüstungsverände- rungen können die angegebenen Werte beeinflussen.

**Remarks relating to the rating charts**

The lifting capacities in the structural area are based on DIN 15018 parts 2 and 3 and F.E.M.

The lifting capacities in the stability area are based on DIN 15019 part 2 / ISO 4305 / EN 13000.

Maximum admissible wind velocity for working with telescopic boom is 15 m/sec to 10 m/sec depending at boom length and for working with fly jib 10 m/sec.

The lifting capacities are shown in metric tons.

The weight of load handling devices such as hook blocks, slings, etc., must be considered as part of the load and must be deducted from the lifting capacities.

The lifting capacities for the telescopic boom apply to a crane with no boom extensions being stowed or mounted on the crane.

The working radius is the horizontal distance from the centre of rotation to the centre of the freely suspended non-oscillating load.

The lifting capacities are subject to change without prior notice.

The above remarks are for basic information only and the operator's manual must be consulted before operating this crane. All data and performances refer to the standard crane. The addition of optional and other equipment may affect the performance of the crane.

**Remarques relatives aux tableaux des charges**

Les forces de levage sont conformes aux normes DIN 15018, p. 2 et 3, et F.E.M.

Les forces de levage dans la partie de stabilité au renversement sont conformes aux normes DIN 15019, chap. 2 / ISO 4305 / EN 13000.

Des vitesses de vent sont admissibles entre 10 m/s jusqu'à max 15 m/s en fonction de la longueur de flèche.

Les forces de levage sont données en tonnes métriques.

Le poids du crochet-moufle et de tous les accessoires d'élingage font partie de la charge et sont à déduire des charges indiquées.

Les forces de levage indiquées pour la flèche télescopique s'entendent fléchette déposée.

Comme portée, on entend la distance horizontale du centre de la couronne de rotation au centre de la charge librement suspendue et non oscillante.

Sauf modification de forces de levage.

Les données ci-dessus servent à titre d'information. Avant la mise en marche de la grue il est conseillé d'étudier les instructions de service. Toutes les données indiquées ci-dessus se réfèrent à la machine de base. Tout changement de l'équipement de la grue peut influencer ces valeurs.

**Notas relativas a los graficos de carga**

En cuanto a los datos referentes a resistencia, las capacidades de carga están basados sobre las normas DIN 15018, pág. 2 y 3, y F.E.M.

En cuanto a los datos referentes a estabilidad anti-vuelco, las capacidades de carga están basados sobre las normas DIN 15019, Cap. 2 / ISO 4305 / EN 13000.

En independencia a la longitud de la pluma, están toleradas velocidades de viento de entre 10 m/s y 15 m/s.

Las capacidades de carga indicadas en las tablas corresponden a toneladas métricas.

Hay que deducir los pesos del gancho, eslingas y de otros dispositivos para fijación de cargas de los valores indicados en las tablas.

Las capacidades de carga referentes a la pluma telescópica valen solamente si el plumín está desmontada.

Como alcance se entiende la distancia horizontal desde el centro de la corona de giro hasta el centro de la carga suspendida libremente y no oscilante.

Salvo modificación de capacidades de carga, sin previo aviso.

Los datos arriba indicados sirven solamente para su información. Hay que leer las instrucciones para el uso antes de la puesta en servicio de la máquina. Todos los datos mencionados en las presentes tablas rigen para los modelos standard. Cualquier modificación del equipo montado puede dar lugar a modi-ficaciones de aquellos valores.

Gegengewichtvarianten  
Counterweight versions  
Variations des contrepoids  
Variaciones de contrapeso

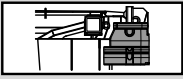
 <b>Gegengewicht / Counterweight</b> <b>Contrepoids / Contrapeso</b>	2x	1x	1x	1x	1x	1x
	①	②	③	④	⑤	⑥
(t)	0.4	5.2	3.1	2.0	3.5	0.4

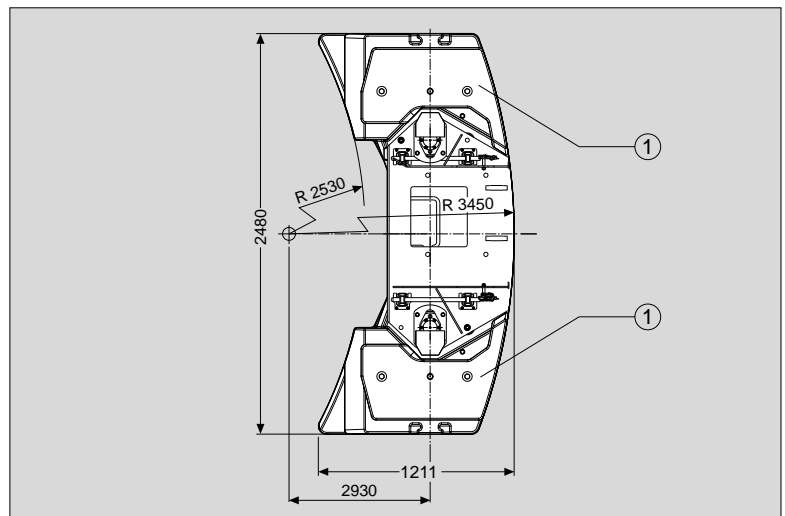
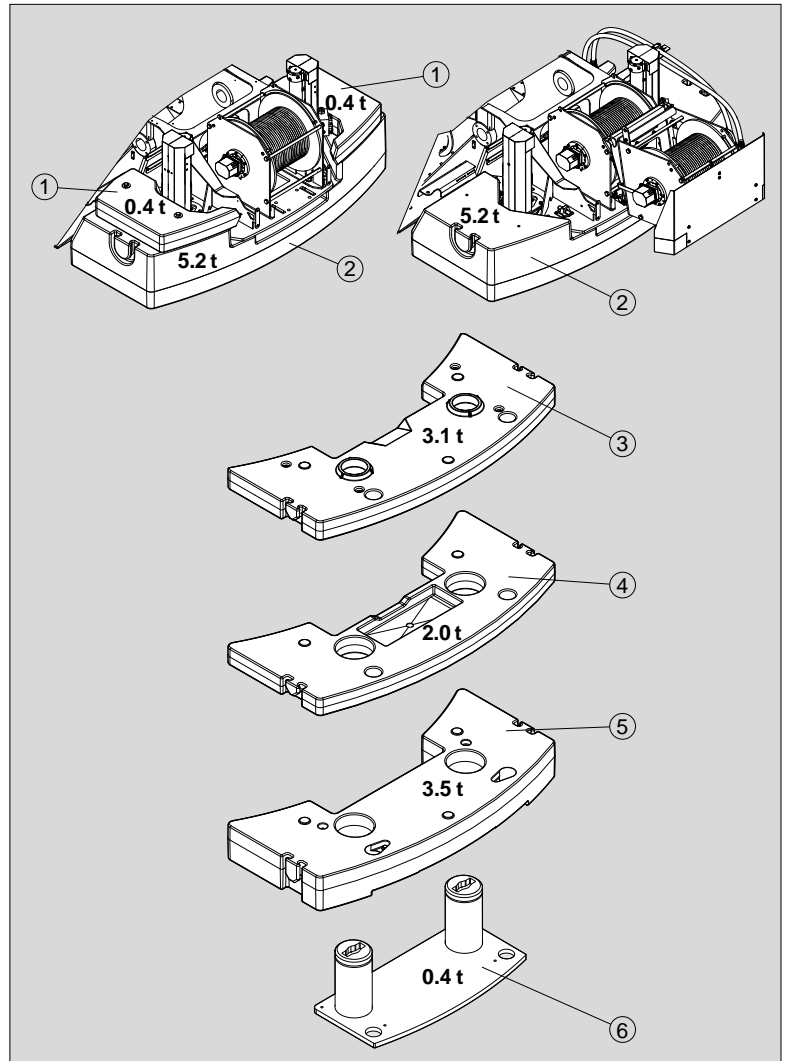
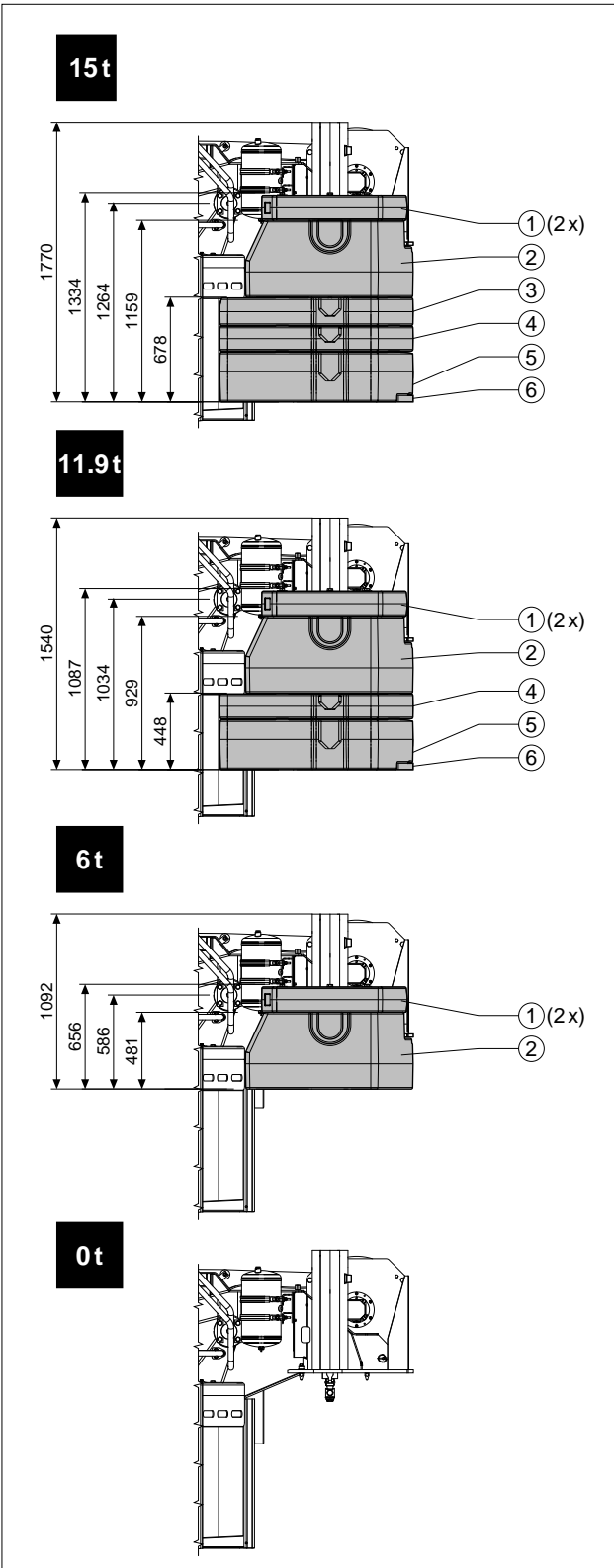

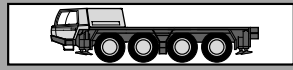

**Rahmen** Verwindungs- und biegesteife Schweißkonstruktion aus hochfestem Feinkornstahl.

**Abstützung** 4-Punkt-Abstützung, hydraulisch, Bedienungsmöglichkeiten an beiden Seiten des Fahrgestelles und in der Oberwagenkabine.  
Abstützbasis 6,4 m (und 4,4 m) x 7,8 m.

**Motor** Mercedes-Benz 6-Zylinder-Dieselmotor OM 501 LA (Euromot III B), wassergekühlt, Leistung 320 kW (435 PS) bei 1800 min<sup>-1</sup>. Drehmoment 2100 Nm (214 kpm) bei 1300 min<sup>-1</sup>. Motorleistung nach 80/1269/EWG. Kraftstoffbehälter 330 l. AdBlue-Behälter 40 l.

**Getriebe** ZF-AS-Tronic 12 AS 2302 mechanisches Schaltgetriebe mit elektronisch-pneumatisch betätigter Trockenkupplung und vollautomatischer Schaltung mit 12 Vorwärts- und 2 Rückwärtsgängen.  
Power/Economy Modus.

**Verteilergetriebe** 2-stufiges Verteilergetriebe.

**Antrieb** 8 x 6 (8 x 8 Option).

#### Achsen

1. Achse: gelenkt, nicht angetrieben.
2. Achse: gelenkt, angetrieben, Differentialsperre quer.
3. Achse: gelenkt, angetrieben, Differentialsperre längs und quer.
4. Achse: gelenkt, angetrieben, Differentialsperre quer.

**Achsaufhängung** Hydropneumatische Federung mit Niveauregulierung.

**Bremsen** Druckluft-Zweikreis-Bremsanlage mit ABS System. Feststellbremse als Federspeicherbremse an der 2., 3. und 4. Achse wirkend. Intarder und Konstantdrosselanlage mit Auspuffklappenbremse als Dauerbremse.

**Räder** 8-fach 385/95 R 25 (14.00 R 25), (Breite 2,55 m).

**Lenkung** ZF-Servocom-Zweikreishydraulenlenkung. Mechanische Lenkung der 1. und 2. Achse und Mittlenken der 4. Achse bis zu einer Geschwindigkeit von 25 km/h, hydraulisch unterstützt, mit Notlenkpumpe. Lenkung aller Achsen möglich. Hydrostatische Lenkung aller Achsen aus der Oberwagenkabine.

**Unterwagenkabine** Zwei-Mann-Frontfahrerhaus in Stahl-Kunststoff-Verbund-Konstruktion, Sicherheitsverglasung, luftgedeferte Sitze (Fahrersitz mit Heizung) und motorabhängige Warmwasserheizung, Radio-CD-Player, Kontroll- und Bedienungselemente für den Fahrbetrieb.  
Tempomat/Bremsomat-Funktion.

**Elektrische Anlage** 24 Volt-Gleichstrom, 2 Batterien, Abstützfeldbeleuchtung.  
Die elektrische Anlage entspricht der EG-Norm.

**Zusatzausrüstung** (gegen Mehrpreis)  
Anhängerkupplung, motorunabhängige Zusatzheizung mit Motorvorwärmung, Klimaanlage, 8 x 8 Antrieb, 445/95 R 25 (16.00 R 25), 525/80 R 25 (20.5 R 25) Bereifung, Reserverad, Sonderlackierung und Beschriftung.

Weitere Zusatzausrüstung auf Anfrage.

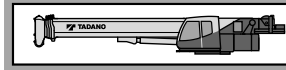

**Rahmen** Verwindungssteife Schweißkonstruktion mit einer außenverzahnten, einreihigen Kugeldrehverbindung, um 360° unbegrenzt drehbar.

**Motor** Mercedes-Benz 4-Zylinder-Dieselmotor OM 924 LA (Euromot III B), wassergekühlt. Drehzahl über Fußpedal stufenlos regelbar, Leistung 95 kW (129 PS) bei 2200 min<sup>-1</sup>. Drehmoment 500 Nm (51 kpm) bei 1200 - 1600 min<sup>-1</sup>. Motorleistung nach 80/1269/EWG.  
Kraftstoffbehälter 200 l. AdBlue-Behälter 8 l.

**Hydraulik System** Diesel-hydraulisch mit 3-Kreishydraulik, 1 leistungsgeregelte Axialkolbendoppelpumpe (hydraulisch verstellbar) und 1 Zahnrad-Doppelpumpe, Ölkühler.

**Steuerung** Zwei 4-fach Kreuzsteuerhebel mit elektrischer Vorsteuerung.

**Teleskopausleger** Fünfteiliger Teleskopausleger aus hochfestem Feinkornstahl, bestehend aus einem Grundausleger und 4 Teleskopteilen, 1 Teleskopzylinder, hydraulisch unter Teillast teleskopierbar. 11,0 m - 44,0 m lang.

**Wippwerk** Ein Differentialzylinder mit angebautem Senkbremsventil.

**Hubwerk** Axialkolben-Motor, Hubwerkstrommel mit eingebautem Planetengetriebe und federbelasteter Hydro-Lamellenbremse mit integriertem Freilauf beim Heben.  
Hubseil mit 'Super-Stop' Einrichtung.

**Drehwerk** Axialkolben-Motor, zweistufiges Planetengetriebe mit fußbetätigter Betriebsbremse und Feststellung.  
Drehgeschwindigkeit stufenlos von 0 - 2 min<sup>-1</sup>.

**Gegengewicht** Standard 'Taxi' 11,9 t teilbar.  
Die Bedienung erfolgt aus der Oberwagenkabine.

**Oberwagenkabine** Großräumige Krankabine in Stahl-Kunststoff-Ausführung mit Sicherheitsverglasung und getönten Scheiben, kippbarem Arbeitsplatz mit verstellbarem, hydraulisch gedämpftem Fahrersitz mit Heizung, motorunabhängige Warmwasserheizung, Radio-CD-Player, Kontroll- und Bedienungselemente für Kranbetrieb, Abstützbetätigung und Verfahrbarkeit vom Oberwagen.

**Elektrische Anlage** 24 Volt-Gleichstrom, 2 Batterien.

**Sicherheitseinrichtungen** Lastmomentbegrenzung (LMB), Arbeitsbereichsbegrenzung, Hubendschalter, Windenendschalter, Seilwindendrehmelder, Sicherheitsventile gegen Rohr- und Schlauchbrüche. Sperrventile an Hydraulik-Zylindern.

**Zusatzausrüstung** (gegen Mehrpreis)  
'Lift Adjuster', Auslegerverlängerung 9,0 m / 16,0 m wahlweise abwinkelbar 0°, 20° und 40° oder hydraulisch 0°- 40°, Schwerlastspitze 1,6 m, Zusatzgegengewicht 3,1 t, verschiedene Unterflaschen, 2. Hubwerk (wie Hauptwinde), Drehbereichsbegrenzung, motorunabhängige Heizung mit Motorvorwärmung, Zusatzölkühler, Zentralschmieranlage, Klimaanlage, Sonderlackierung und Beschriftung.

Weitere Zusatzausrüstung auf Anfrage.

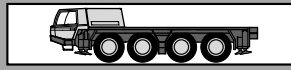

**Frame** Torsion resistant, welded construction made from high strength, fine-grained steel.

**Outriggers** 4 point, telescopic hydraulic outriggers with controls on both sides of carrier and in superstructure cab. Outrigger base 6.4 m (4.4 m mid extension) x 7.8 m.

**Carrier engine** Mercedes-Benz 6 cylinder model OM 501 LA (Euromot III B), water-cooled diesel engine. Rated at 320 kW (435 HP) at 1800 min<sup>-1</sup>. Torque 2100 Nm (214 kpm) at 1300 min<sup>-1</sup>. Engine rating according to 80/1269/EWG. Fuel tank 330 l. AdBlue-tank 40 l.

**Transmission** ZF-AS-Tronic 12 AS 2302 mechanical transmission with electro-pneumatically operated dry-type clutch and automatic gear shifting with 12 forward gears and 2 reverse gears. Power/Economy mode.

**Transfer Case** Two stage.

**Drive** 8 x 6 (8 x 8 option).

#### Axles

1<sup>st</sup> axle: steered, not driven.  
 2<sup>nd</sup> axle: steered, driven, with differential lock, transverse.  
 3<sup>rd</sup> axle: steered, driven, with differential locks longitudinal and transverse.  
 4<sup>th</sup> axle: steered, driven, with differential lock, transverse.

**Suspension** Hydro-pneumatic with levelling adjustment.

**Brake system** Service brakes: dual circuit compressed air system with ABS. Parking brake: spring loaded type acting on 2<sup>nd</sup>, 3<sup>rd</sup> and 4<sup>th</sup> axles. Auxiliary brakes: intarder, engine exhaust brake and constant throttle engine brake system.

**Tyres** (8) 385/95 R 25 (14.00 R 25), (width 2.55 m).

**Steering system** ZF-Servocon, dual circuit hydraulic steering with emergency steering pump, mechanical hydraulically-assisted steering of front two axles and automatic steering of the 4<sup>th</sup> axle up to a travel speed of 25 km/h. Steering of all axles possible. All axles steered hydrostatically from superstructure cab.

**Carrier cab** Two man full width cab of composite (steel sheet metal and fibre-glass) structure, with safety glass, air-cushioned adjustable seats (drivers seat with heater) and engine dependent hot-water heater, radio-CD-player, complete controls and instrumentation for road travel. Speed and brake control.

**Electrical system** 24 volt DC system, 2 batteries, outrigger area lighting.  
 Electrical system conforms with EEC regulations.

**Optional Equipment** (at extra charge)  
 Towing attachment, engine independent additional heater with engine pre-heat, air conditioning, 8 x 8 drive, 445/95 R 25 (16.00 R 25), 525/80 R 25 (20.5 R 25) tyres, spare wheel and tyre, special painting and lettering.  
 Further optional equipment available upon request.

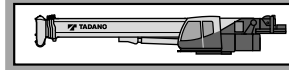

**Frame** Torsion-resistant, all-welded structure of high strength steel. Connected to carrier by single-row ball-bearing slewing ring with external gearing for 360° continuous rotation.

**Superstructure engine** Mercedes-Benz 4 cylinder model OM 924 LA (Euromot III B), water cooled, diesel engine. RPM infinitely variable via foot pedal, rating 95 kW (129 HP) at 2200 min<sup>-1</sup>. Torque 500 Nm (51 kpm) at 1200 - 1600 min<sup>-1</sup>. Engine rating according to 80/1269/EWG. Fuel tank 200 l. AdBlue-tank 8 l.

**Hydraulic system** Three circuit diesel hydraulic system with 1 power controlled axial piston double pump (hydraulically adjustable) and 1 double gear pump, oil cooler.

**Controls** Electrical, 2 joy-stick levers for simultaneous operation of crane motions.

**Telescopic boom** 5 sections, made of high tensile, fine-grained steel, consisting of 1 base section and 4 telescoping sections extended by means of a single telescopic cylinder. All telescope sections extendable under partial load. 11.0 m to 44.0 m long.

**Derricking system** 1 double acting hydraulic cylinder with integral brake and holding valve.

**Main winch** Axial piston motor, winch drum with integrated planetary reduction and with hydraulically controlled spring-loaded, multiple disc brake and with integrated free rotation (no sagging of load when hoisting). Hoist cable with 'Super-Stop' easy reeving system.

**Slewing system** Axial piston motor with two-stage planetary reduction with a foot actuated service and a parking brake. Speed infinitely variable 0 - 2 min<sup>-1</sup>.

**Counterweight** Standard 'Taxi' 11.9 t divisible, assembled and disassembled by hydraulic cylinders controlled from superstructure cab.

**Superstructure cab** Spacious panoramic cab of composite structure with safety (tinted) glass windows, tiltable cockpit with hydraulically cushioned adjustable seat with heater, engine independent hot-water heater, radio-CD-player, complete controls and instrumentation for crane operation, on-site travelling and outriggers.

**Electrical system** 24 volt DC system, 2 batteries.

**Safety devices** Load moment device (LMD), working area limiter, hoist limit switch, lower limit switch and drum turn indicator, safety valves against pipe and hose rupture. Holding valves on hydraulic cylinders.

**Optional Equipment** (at extra charge)  
 'Lift Adjuster', boom extension 9.0 m / 16.0 m offsets 0°, 20° and 40° or hydraulically 0°- 40°, heavy duty jib 1.6 m, additional counterweight 3.1 t, selection of hook blocks, auxiliary winch (same as main winch), slewing area limitation, engine independent heater with engine pre-heat, additional oil cooler, central lubricating system, air conditioning, special painting and lettering.  
 Further optional equipment available upon request.

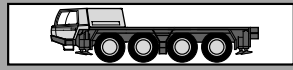

**Châssis** Construction mécanosoudée, en acier à grain fin très rigide, résistant aux flexions et aux torsions.

**Calage** Dispositif de calage horizontal et vertical en 4 points, entièrement déployable hydrauliquement. Commande des mouvements sur les deux côtés du porteur et depuis la cabine de la superstructure. Calage 6,4 m (aussi 4,4 m) x 7,8 m.

**Moteur** Mercedes-Benz diesel 6 cylindres, modèle OM 501 LA (Euromot III B), refroidi par eau, de 320 kW (435 CV) à 1800 min<sup>-1</sup>. Couple: 2100 Nm (214 kpm) à 1300 min<sup>-1</sup>. Puissance selon 80/1269/EWG. Capacité du réservoir 330 l. AdBlue-capacité du réservoir 40 l.

**Boîte de vitesse** Boîte mécanique ZF-AS-Tronic, modèle 12 AS 2302 avec embrayage électro-pneumatique réglé à commande et boîte automatique, 12 vitesses AV et 2 vitesses AR. Mode max. performance/économique.

**Boîte de transfert** À 2 gammes.

**Entraînement** 8 x 6 (8 x 8 option).

#### Essieux

1<sup>er</sup> essieu: directeur, non entraîné.

2<sup>ième</sup> essieu: directeur, entraîné, blocage de différentiel transversal.

3<sup>ième</sup> essieu: directeur, entraîné, blocage de différentiel longitudinal et transversal.

4<sup>ième</sup> essieu: directeur, entraîné, blocage de différentiel transversal.

**Suspension** Hydro-pneumatique, avec réglage de niveau.

**Freins** Système à air comprimé, à double circuit avec système ABS. Frein de stationnement: avec accumulateurs à ressort agissant sur le 2<sup>ième</sup>, 3<sup>ième</sup> et 4<sup>ième</sup> essieu. Frein continu: Intarder et frein sur échappement avec étrangleur.

**Pneus** 8 x 385/95 R 25 (14.00 R 25), (largeur 2,55 m).

**Direction** Servocom à double circuit, marque ZF. Direction mécanique du 1<sup>er</sup> et 2<sup>ième</sup> essieu, direction à assistance hydraulique du 4<sup>ième</sup> essieu jusqu'à une vitesse de 25 km/h, avec pompe de secours pour direction. Direction de tous les essieux possible. Direction hydro-statique de tous les essieux depuis la cabine du grutier.

**Cabine** Cabine bi-place, construction en matière composite fibre de verre et acier. Vitrage en verre de sécurité, siège conducteur chauffant suspendu hydrauliquement. Chauffage à eau chaude relié au moteur, radio-CD-player. Organes de contrôle et de commande pour la conduite. Régulateur de vitesse, système automatique de freinage.

**Système électrique** 24 V courant continu, 2 batteries, éclairage des points de calage. Conforme aux normes CE.

**Équipement supplémentaire** (avec supplément de prix) Attache-remorque, chauffage auxiliaire indépendant du moteur avec préchauffage du moteur, climatisation, Entraînement 8 x 8, pneus 445/95 R 25 (16.00 R 25), 525/80 R 25 (20.5 R 25), roue de secours, peinture spéciale et inscription.

Autres équipements supplémentaires sur demande.

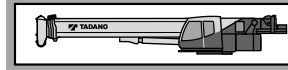

**Plate forme** Construction mécano-soudée résistante à la torsion. Couronne d'orientation à billes à une rangée, à denture extérieure, permettant une rotation illimitée sur 360°.

**Moteur** Mercedes-Benz diesel 4 cylindres, modèle OM 924 LA (Euromot III B), refroidi par eau, Réglage du nombre de tours par pédale, de 95 kW (129 CV) à 2200 min<sup>-1</sup>. Couple: 500 Nm (51 kpm) à 1200 - 1600 min<sup>-1</sup>. Puissance selon 80/1269/EWG. Capacité du réservoir 200 l. AdBlue-capacité du réservoir 8 l.

**Système hydraulique** Diesel-hydraulique à 3 circuits, 1 double pompe à pistons axiaux à régulation de puissance (à réglage hydraulique) et 1 pompe à engrenages, refroidisseur d'huile.

**Commande** 2 manipulateurs à commande en croix (4 sens), assistés électriquement.

**Flèche télescopique** 1 flèche de base et 4 éléments télescopiques en acier fin, 1 vérin télescopique, hydrauliquement télescopable avec charge partielle. Longueur 11,0 m à 44,0 m.

**Mécanisme de relevage** 1 vérin différentiel muni de clapet de freinage de descente.

**Mécanisme de levage** Moteur hydraulique, tambour de levage avec boîte planétaire incorporée, frein d'arrêt à disques multiples à ressort, libéré lors du levage. Câble de levage avec dispositif 'Super-Stop'.

**Orientation** Moteur hydraulique avec entraînement planétaire à 2 gammes. Frein de service actionné par l'intermédiaire d'une pédale et frein de stationnement. Vitesse de rotation 0 à 2 min<sup>-1</sup> en continu.

**Contrepoids** Standard 'Taxi' 11,9 t divisible, commandé depuis la cabine du grutier.

**Cabine du grutier** Cabine de grue spacieuse, construction en matière combinée acier/synthétique, avec vitrage de sécurité en verre teinté, siège chauffant, réglable et amorti hydrauliquement, inclinable avec instruments de commande, chauffage à eau chaude indépendant du moteur, radio-CD-player, éléments de commande et de contrôle pour travaux sur chantier, conduite et calage de la grue depuis la cabine du grutier.

**Système électrique** 24 V courant continu, 2 batteries.

**Dispositifs de sécurité** Limiteur de charge (CEC), limitation de zone de travail, interrupteur de fin de course de levage et de treuil, indicateur du nombre de tours, soupapes de sécurité contre ruptures des conduites et flexibles, clapets sur verins hydrauliques.

**Équipement supplémentaire** (avec supplément de prix) 'Lift Adjuster', fléchette 9,0 m / 16,0 m au choix inclinable 0°, 20° et 40° ou hydrauliquement 0° à 40°, fléchette pour levage lourde 1,6 m, contrepoids additionnel de 3,1 t, sélection de moulles, 2<sup>ième</sup> treuil de levage (identique au treuil principale), limitation de rotation, chauffage auxiliaire avec préchauffage du moteur, refroidisseur d'huile supplémentaire, graissage centralisé, climatisation, peinture spéciale et inscription.

Autres équipements supplémentaires sur demande.



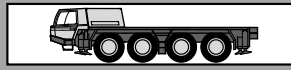

**Chasis portante** Construcción de acero de alta resistencia soldado, resistente a la torsión y a la flexión.

**Estabilizadores** Estabilizadores hidráulicos de 4 puntos. Posibilidad de manejo desde ambos lados del chasis portante y desde la cabina de la grúa. Extensión de los estabilizadores: 6,4 m (y 4,4 m) x 7,8 m.

**Motor** Mercedes-Benz modelo OM 501 LA (Euromot III B), 6 cilindros, diesel, refrigerado por agua. Nominal 320 kW (435 CV) a 1800 min<sup>-1</sup>. Par 2100 Nm (214 kpm) a 1300 min<sup>-1</sup>. Potencia del motor según 80/1269/EWG. Depósito de combustible de 330 l. Depósito AdBlue 40 l.

**Transmisión** Transmisión mecánica tipo ZF-AS Tronic modelo 12 AS 2302 con accionamiento electro - neumáticamente embrague en seco y cambio automático 12 marchas delanteras y 2 marchas traseras. Modo rendimiento máximo / económico.

**Transmisión** Caja de distribución (transfer) con 2 relaciones de velocidad.

**Tracción** 8 x 6 (8 x 8 opción).

#### Ejes

- 1º eje: de dirección, no accionado.
- 2º eje: de dirección, accionado, con bloqueo diferencial transversal.
- 3º eje: de dirección, accionado, con bloqueo diferencial transversal y longitudinal.
- 4º eje: de dirección, accionado, con bloqueo diferencial transversal.

**Suspensión** Suspensión hidroneumática con regulación de nivel.

**Sistema de frenos** Accionamiento neumático de doble circuito con sistema anti bloqueo ABS. Freno de estacionamiento con acumuladores de muelle. Con actuación sobre los ejes 2º, 3º y 4º. Intarder y freno continuo: Freno de motor diesel en el escape.

**Neumáticos** 8 x 385/95 R 25 (14.00 R 25), (ancho 2,55 m).

**Dirección** Hidráulica ZF Servocom de doble circuito. Dirección mecánica al 1º y 2º eje y direccionable al 4º eje hasta una velocidad de 25 km/h. Bomba hidráulica de emergencia accionada por la transmisión. Dirección a todos los ejes. Desde la cabina de la superestructura: dirección hidrostática a ambos ejes.

**Cabina** Cabina para dos personas, en construcción de acero y fibra de vidrio. Cristales de seguridad, asiento con suspensión neumática, asiento de conductor calefactado. Calefacción por agua caliente del motor, radio-CD-player. Elementos de control y manejo para circular por carretera. Regulador de velocidad, sistema automático de frenado.

**Sistema eléctrico** Sistema de 24 V c.c. con dos baterías, faros de trabajo en los estabilizadores. El sistema eléctrico cumple la normativa CEE.

**Equipo adicional** (con suplemento de precio)  
Embrague de remolque, calefacción adicional con precalefacción del motor, climatización, Tracción 8 x 8, neumáticos 445/95 R 25 (16.00 R 25), 525/80 R 25 (20.5 R 25), rueda de repuesto, pintura especial e rotulación.  
Otros equipamientos sobre pedido.

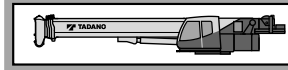

**Superestructura** Construida en aceros soldados, resistente a la torsión. Corona de giro con rodamiento de una fila de bolas con dientes externos para giro continuo de 360°.

**Motor** Mercedes-Benz modelo OM 924 LA (Euromot III B), 4 cilindros, diesel, refrigerado por agua. Las revoluciones aumentan de forma gradual accionado el acelerador. Nominal 95 kW (129 CV) a 2200 min<sup>-1</sup>. Par 500 Nm (51 kpm) a 1200 - 1600 min<sup>-1</sup>. Potencia del motor según 80/1269/EWG. Depósito de combustible de 200 l. Depósito AdBlue 8 l.

**Sistema hidráulico** Sistema hidráulico de 3 circuitos, 1 bomba doble de pistones axiales de caudal variable (regulable hidráulicamente) y una bomba de engranajes, enfriador de aceite.

**Mandos** 2 palancas de control de tipo joy-stick para movimientos simultáneos de la grúa (4 direcciones), asistidos eléctricamente.

**Pluma telescópica** 5 secciones, un tramo base y 4 telescópicos de acero de alta resistencia soldado, 1 cilindro hidráulico, los tramos se pueden telescopar hidráulicamente bajo carga. Longitud de 11,0 m a 44,0 m.

**Elevación de pluma** Mediante un cilindro hidráulico de doble efecto con válvula de retención integrada.

**Cabrestante principal** Motor hidráulico de pistones axiales y caudal fijo. Tambor del cabrestante con reducción planetaria y frenos de disco múltiples accionado, con sistema libre de elevación. Cable de elevación con sistema fácil de guiado y 'Super-Stop'.

**Sistema de giro** Motor hidráulico de pistones axiales con reducción planetaria de dos etapas. Freno de servicio controlado por pedal y freno de estacionamiento. Velocidad de giro variable de 0 a 2 min<sup>-1</sup>.

**Contrapeso** El estándar 'Taxi' 11,9 t divisible, se acciona desde la cabina de la grúa.









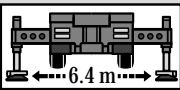

**Cabina de la grúa** Cabina espaciosa y confortable, en construcción de acero y fibra de vidrio, con cristales tintados de seguridad. Asiento de operador regulable amortiguado hidráulicamente, inclinable junto con los instrumentos y mandos, asiento calefactado. Calefacción por agua caliente independiente del motor, radio-CD-player. Elementos de control y mando para el manejo de la grúa y para el desplazamiento en obra. Mandos para nivelación y extensión de los estabilizadores.

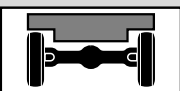





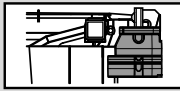
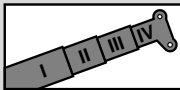
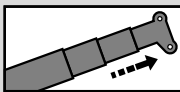
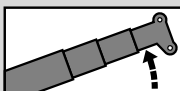

**Sistema eléctrico** Sistema de 24 V c.c. con dos baterías.

**Medidas de seguridad** Limitación del momento de carga (LMC), limitación del área de trabajo, interruptor de final de elevación, interruptor de 3 últimas vueltas en cabrestante, indicador de bajada o subida del cable del cabrestante, válvulas de seguridad para rotura de tubos y latiguillos. Válvulas de retención en los cilindros hidráulicos.

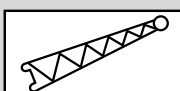
**Equipo adicional** (con suplemento de precio)  
'Lift Adjuster', plumín de 9,0 m / 16,0 m regulable de 0°, 20° y 40° (o hidráulicamente 0° a 40°), plumín de carga pesada de 1,6 m, contrapeso adicional de 3,1 t, selección de ganchos, 2º cabrestante, (similar a cabrestante principal), limitador de giro, calefacción independiente del motor y precalefacción del motor, enfriador adicional, sistema de engrase central, climatización, pintura especial e rotulación.  
Otros equipamientos sobre pedido.

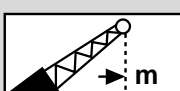
Symbolerklärung  
 Symbols  
 Glossaire des symboles  
 Glosario de símbolos

	Siehe Seite 20 As on Page 20 Voyez la page 20 Véase la pagina 20
	Abstützung Outriggers Calage Estabilizadores
	Getriebe / Gang Transmission / Gear Boîte de vitesse / Rapport Transmisión / Marchas
	Achslast Axle load Charge à l'essieu Carga por eje
	<b>445/95</b> <b>(16.00)</b>
	Räder / Größe Tyres / Size Pneus / Largeur Neumáticos / Tamaño de ruedas
	Gelände Off road Tout-terrain Todo terreno
	Straße On road En route En carretera
	Geschwindigkeiten Speeds Vitesses Velocidades
	Steigfähigkeit Gradeability Abtitude en pente Superacion de pendientes
	Drehwerk Slewing system Orientation Sistema de giro
	Gegengewicht Counterweight Contrepoids Contrapeso
	Nach hinten Over rear A l'arrière Sobre la parte trasera

	Gegengewichtvarianten Counterweight versions Variations des contrepoids Variaciones de contrapeso
	Teleskopausleger Telescopic boom Flèche télescopique Pluma telescópica
	Teleskopieren Boom telescoping Télescopage de flèche Telescopaje de pluma
	Wippwerk Derricking system Mécanisme de relevage Elevación de pluma
	Ausladung Radius Portée Radio
	Auslegerverlängerung Boom extension Fléchette Plumín
	Auslegerverlängerung hydraulisch Boom extension hydraulically Fléchette hydrauliquement Plumín hidráulicamente
	Ausladung Radius Portée Radio
	Hubwerk Main winch Mécanisme de levage Cabrestante principal
	2. Hubwerk Auxiliary winch 2 <sup>ème</sup> treuil de levage 2 <sup>º</sup> cabrestante
	Unterflasche / Hakengeschirr Hook block / Swivel hook Moufle / Elingues Gancho / Gancho de bola

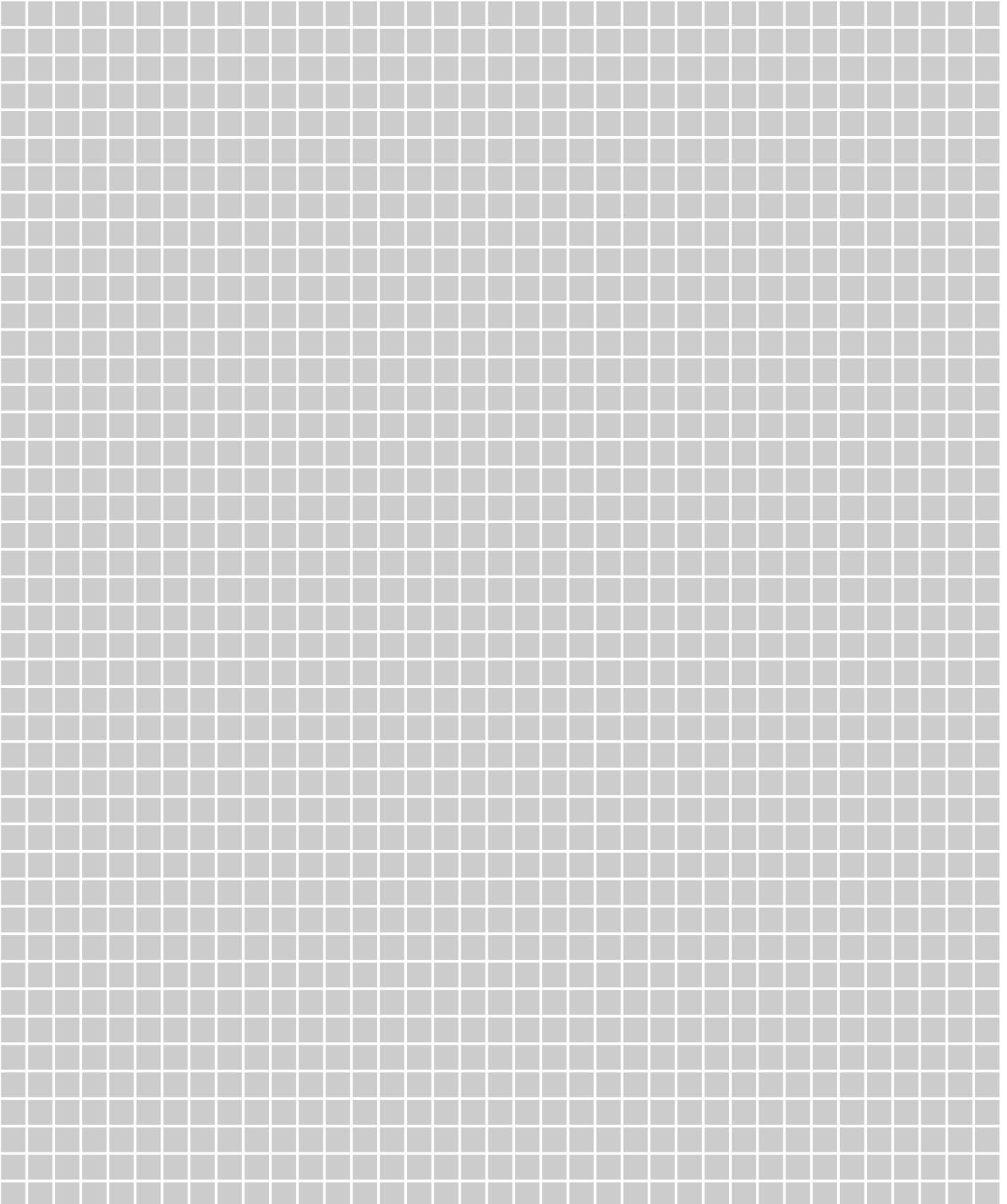

## Worldwide offices

---

### International

#### **TADANO Ltd.**

International Division  
4-12, Kamezawa 2-chome  
Sumida-Ku, Tokyo 130-0014, Japan  
Phone: +81-3-3621-7750  
Fax: +81-3-3621-7785  
E-mail: [tdnihq@tadano.co.jp](mailto:tdnihq@tadano.co.jp)

#### **TADANO America Corporation**

4242 West Greens Road  
Houston, TX 77066, USA  
Phone: +1-281-869-0030  
Fax: +1-281-869-0040  
E-mail: [sales@tadano-cranes.com](mailto:sales@tadano-cranes.com)

#### **TADANO MANTIS Corporation**

1705 Columbia Avenue, Suite 200  
Franklin, Tennessee USA 37065  
Phone: +1-800-272-3325  
Fax: +1-615-790-6803  
E-mail: [sales@mantisranes.com](mailto:sales@mantisranes.com)

#### **TADANO Ltd. Middle East Representative Office**

P.O.Box 18302, LOB15-323  
Jebel Ali Free Zone, Dubai, UAE  
Phone: +971-4-887-1353  
Fax: +971-4-887-1703  
E-mail: [tadano@tadano.ae](mailto:tadano@tadano.ae)

#### **TADANO Oceania Pty Ltd.**

4/12 Archimedes Street Darra  
Queensland 4076  
Australia  
Phone: +61-7-3120-8750  
Fax: +61-7-3120-8760  
E-mail: [pshelton@tadano.com.au](mailto:pshelton@tadano.com.au)

#### **TADANO Ltd. Beijing Office**

Jing Guang Centre, Room 2905  
Hu Jia Lou, Chao Yang Qu  
Beijing, China  
Phone: +86-10-6597-3210  
Fax: +86-10-6597-3220  
E-mail: [beijing@tadano.co.jp](mailto:beijing@tadano.co.jp)

#### **TADANO South China Co. Ltd.**

Room 1803, 18/F Seaview Commercial  
Building 21-24 Connaught Road West  
Hong Kong  
Phone: +852-2544-9310  
Fax: +852-2541-5828  
E-mail: [info@tadanosc.com](mailto:info@tadanosc.com)

#### **TADANO Korea Co. Ltd.**

Dangok Bldg 2F, #642-7, Bokjeong-dong  
Sujeong-gu, Seongnam-si, Gyeonggi-do  
461-830, Korea  
Phone: +82-2-714-1600  
Fax: +82-2-3274-1304  
E-mail: [tadano@korea.com](mailto:tadano@korea.com)

#### **TADANO Asia Pte Ltd.**

11 Tuas View Crescent  
Multico Building  
Singapore 637643  
Phone: +65-6863-6901  
Fax: +65-6863-6902  
E-mail: [Tdn-crane@tadanoasia.com](mailto:Tdn-crane@tadanoasia.com)

#### **Taiwan TADANO Ltd.**

16F, No. 39, Sec. 2 Twng-Hwa S. Rd.  
Taipei  
Taiwan  
Phone: +886-2-2754-0252  
Fax: +886-2-2709-2086  
E-mail: [tadano@ms18.hinet.net](mailto:tadano@ms18.hinet.net)

### Europe

#### **TADANO FAUN GmbH**

Faunberg 2  
91207 Lauf a. d. Pegnitz  
Germany  
Phone: +49-9123-955-0  
Fax: +49-9123-3085  
E-mail: [info@tadanofaun.de](mailto:info@tadanofaun.de)

---

Detaillierte Informationen über unsere Internationalen Händler und Service Niederlassungen finden Sie im Internet.  
For detailed information about our International Distributor and Service Network, please refer to our homepages.  
[www.tadano.co.jp](http://www.tadano.co.jp) + [www.tadanoamerica.com](http://www.tadanoamerica.com) + [www.mantisranes.com](http://www.mantisranes.com) + [www.tadanofaun.de](http://www.tadanofaun.de)

### Herausgeber / Publisher:

#### **TADANO FAUN GmbH**

P.O.Box 10 02 64  
91205 Lauf  
Germany

